

SKB

Rolety - przykłady zabudowy

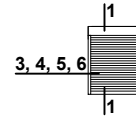

Piktogram (oznaczenie przekroju)

Skala 1:6

Skala rysunku

1 SKB 260 RI

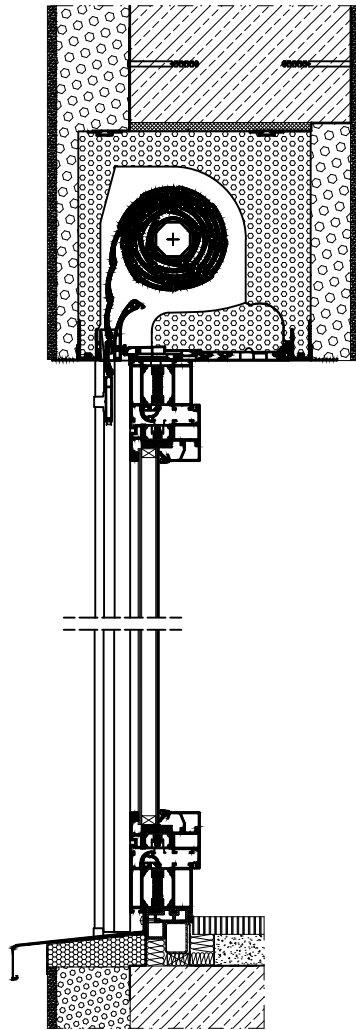

Numer strony

SKB / 26



10/2018

Data aktualizacji

Numer przekroju (zgodny z piktogramem)

Wielkość skrzynki

1 SKB 260 RI

System

Maksymalne wymiary rolet

PA 37 Profil roletowy aluminiowy wypełniony pianką poliuretanową, bezfreonową

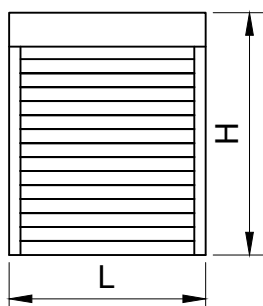

Hmax = 4590 mm
Lmax = 2500 mm
Fmax = H x L = 6.0 m²

PA 39 Profil roletowy aluminiowy wypełniony pianką poliuretanową, bezfreonową

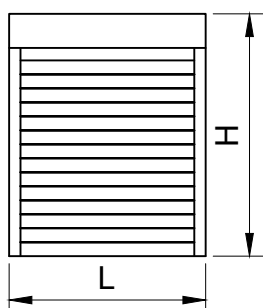

Hmax = 4710 mm
Lmax = 2500 mm
Fmax = H x L = 6.0 m²

PA 40 Profil roletowy aluminiowy wypełniony pianką poliuretanową, bezfreonową

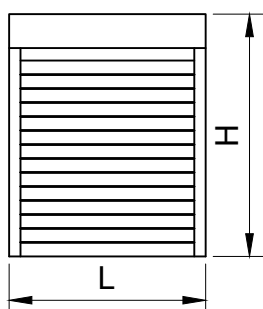

Hmax = 3670 mm
Lmax = 2500 mm
Fmax = H x L = 7.0 m²

PA 43 Profil roletowy aluminiowy wypełniony pianką poliuretanową, bezfreonową

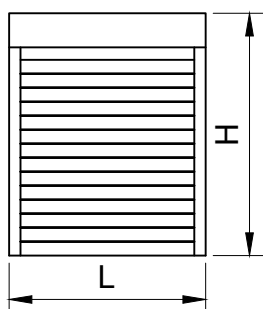

Hmax = 4700 mm
Lmax = 2500 mm
Fmax = H x L = 9.0 m²

Maksymalne wymiary rolet

PA 45

Profil roletowy aluminiowy wypełniony pianką poliuretanową, bezfreonową

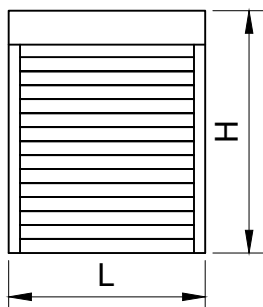

Hmax = 4060 mm
Lmax = 2500 mm
Fmax = H x L = 6.5 m²

PA 52

Profil roletowy aluminiowy wypełniony pianką poliuretanową, bezfreonową

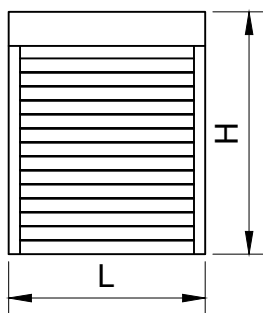

Hmax = 3220 mm
Lmax = 2500 mm
Fmax = H x L = 8.0 m²

PA 55

Profil roletowy aluminiowy wypełniony pianką poliuretanową, bezfreonową

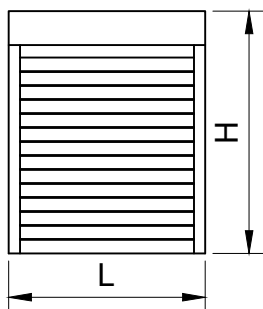

Hmax = 2130 mm
Lmax = 2500 mm
Fmax = H x L = 5.3 m²

Maksymalne wymiary rolet

PT 37 Profil roletowy tworzywowy

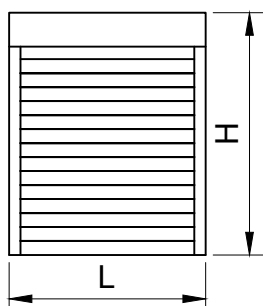

Hmax = 4880 mm
Lmax* = 1600 mm
Fmax = H x L = 3.0 m²

PT 52 Profil roletowy tworzywowy

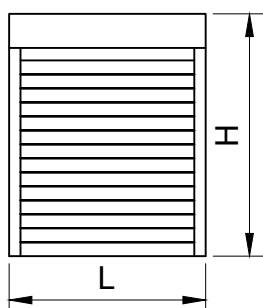

Hmax = 3110 mm
Lmax = 2300 mm
Fmax = H x L = 4.3 m²

Maksymalne wymiary rolet z moskitierą MKT

PA 37
+ MKT

Profil roletowy aluminiowy wypełniony pianką poliuretanową, bezfreonową

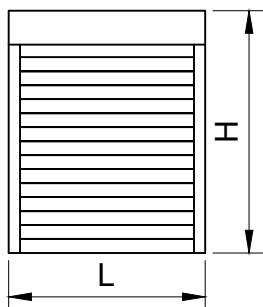

Hmax = 2700 mm
Lmax = 2000 mm
Fmax = H x L = 5.0 m²

PA 39
+ MKT

Profil roletowy aluminiowy wypełniony pianką poliuretanową, bezfreonową

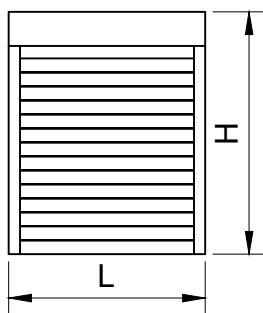

Hmax = 2700 mm
Lmax = 2000 mm
Fmax = H x L = 5.0 m²

PA 40
+ MKT

Profil roletowy aluminiowy wypełniony pianką poliuretanową, bezfreonową

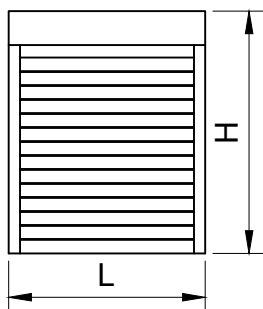

Hmax = 2700 mm
Lmax = 2000 mm
Fmax = H x L = 5.0 m²

PA 43
+ MKT

Profil roletowy aluminiowy wypełniony pianką poliuretanową, bezfreonową

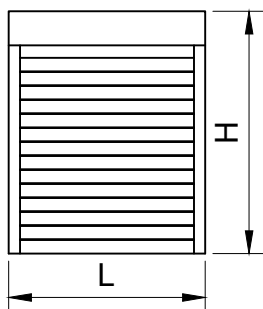

Hmax = 2700 mm
Lmax = 2000 mm
Fmax = H x L = 5.0 m²

Maksymalne wymiary rolet z moskitierą MKT

PA 45
+ MKT

Profil roletowy aluminiowy wypełniony pianką poliuretanową, bezfreonową

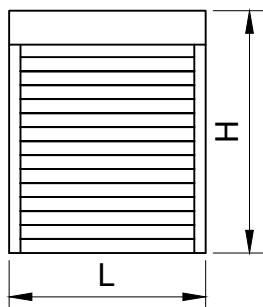

Hmax	= 2700 mm
Lmax	= 2000 mm
Fmax	= H x L = 5.0 m ²

PA 52
+ MKT

Profil roletowy aluminiowy wypełniony pianką poliuretanową, bezfreonową

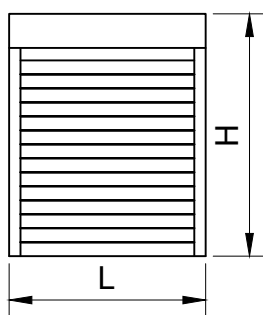

Hmax	= 2650 mm
Lmax	= 2000 mm
Fmax	= H x L = 5.0 m ²

PA 55
+ MKT

Profil roletowy aluminiowy wypełniony pianką poliuretanową, bezfreonową

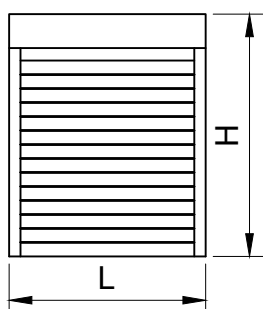

Hmax	= 2400 mm
Lmax	= 2000 mm
Fmax	= H x L = 5.0 m ²

Maksymalne wymiary rolet z moskitierą MKT

PT 37
+ MKT

Profil roletowy tworzywowy

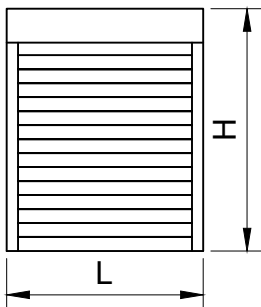

Hmax = 2700 mm
Lmax = 1600 mm
Fmax = H x L = 3.0 m²

PT 52
+ MKT

Profil roletowy tworzywowy

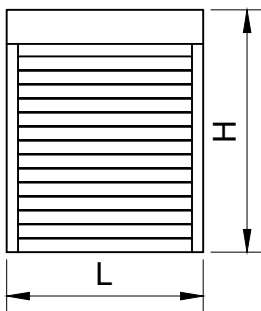

Hmax = 2700 mm
Lmax = 2000 mm
Fmax = H x L = 4.3 m²

Maksymalne wymiary rolet

Maksymalne szerokości zestawu rolet:

- w przypadku zastosowania boków wewnątrz zespolonych PBW SKB

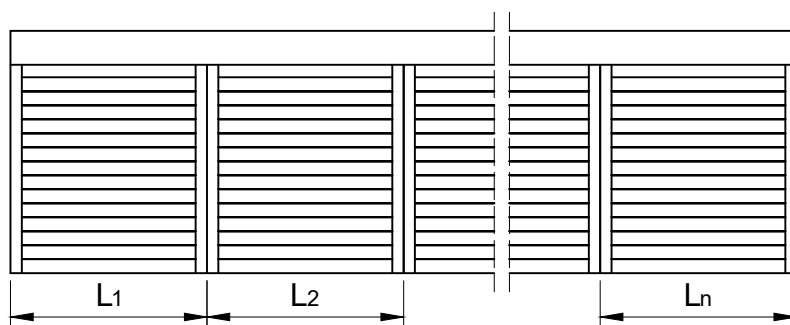

$$L_1, L_2, \dots, L_n \leq 2500 \text{ mm}$$

- w przypadku zastosowania ścianek podziałowych SP/B

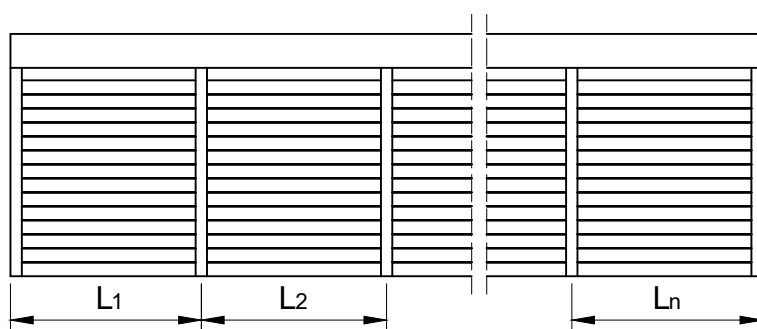

$$L_1, L_2, \dots, L_n \leq 2500 \text{ mm}$$

$$L_1 + L_2 + \dots + L_n \leq 3200 \text{ mm}$$

- w przypadku zastosowania boków wewnątrz zespolonych PBW SKB i ścianek podziałowych SP/B

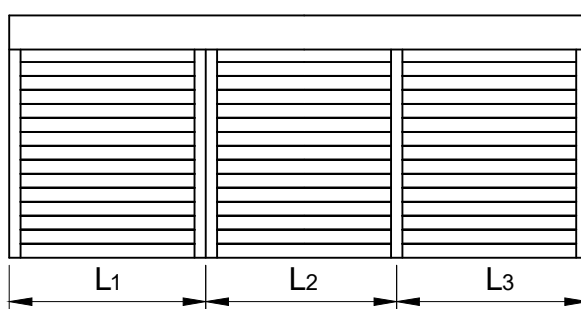

$$L_1, L_2, L_3 \leq 2500 \text{ mm}$$

$$L_2 + L_3 \leq 3200 \text{ mm}$$

Maksymalne wymiary rolet z moskitierą MKT

Maksymalne szerokości zestawu rolet:

- w przypadku zastosowania boków wewnątrz zespolonych PBW SKB

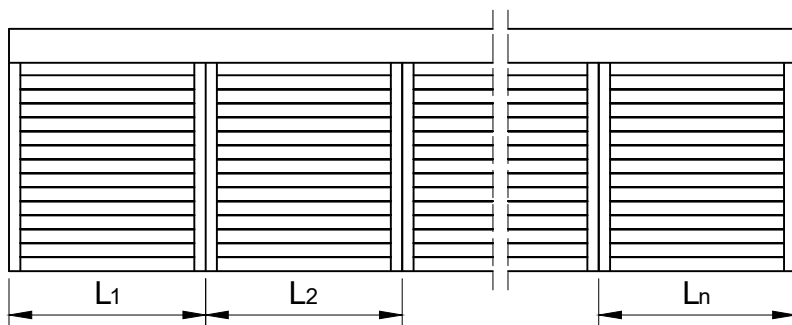

$$L_1, L_2, \dots, L_n \leq 2000 \text{ mm}$$

- w przypadku zastosowania ścianek podziałowych SP/B

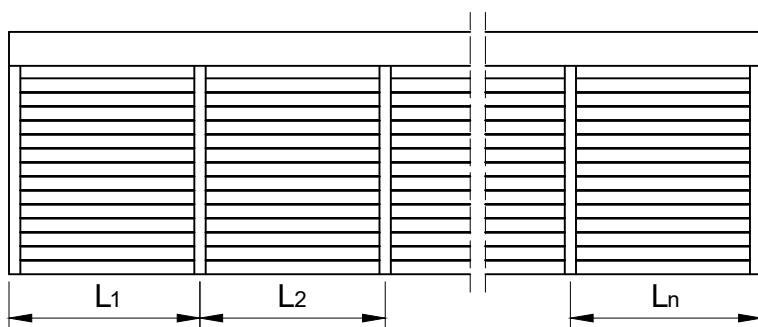

$$L_1, L_2, \dots, L_n \leq 2000 \text{ mm}$$

$$L_1 + L_2 + \dots + L_n \leq 3200 \text{ mm}$$

- w przypadku zastosowania boków wewnątrz zespolonych PBW SKB i ścianek podziałowych SP/B

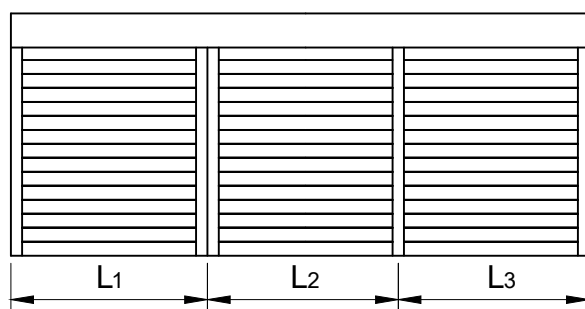

$$L_1, L_2, L_3 \leq 2000 \text{ mm}$$

$$L_2 + L_3 \leq 3200 \text{ mm}$$

Możliwości konfiguracji zestawu rolet o jednakowej wysokości

Roleta pojedyncza

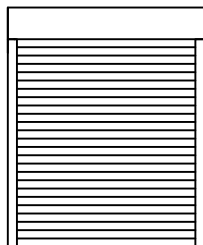

Rodzaje prowadnic

SKB RI

PP 60/12, PP 60/17
PPA 35/12, PPA 35/17
PPD 60/12, PPD 60/17
PPDA 60/12, PPDA 60/17
PPDMW 60/12, PPDMW 60/17

SKB RA

APPRA 45,
PPRA/12, PPRA/17
PPMRA/12, PPMRA/17

SKB F

APPF/B 33, PPF
PPZ 32 MZN

Zestaw rolet o jednakowej wysokości (w jednej skrzynce)

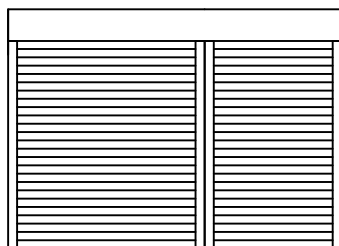

Rodzaje prowadnic

SKB RI

PP 60/12, PP 60/17
PPA 35/12, PPA 35/17
PPD 60/12, PPD 60/17
PPDA 60/12, PPDA 60/17
PPDMW 60/12, PPDMW 60/17

SKB RA

APPRA 45,
PPRA/12, PPRA/17
PPMRA/12, PPMRA/17

Zestaw rolet o jednakowej wysokości (w jednej skrzynce)

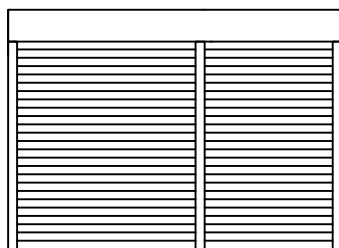

Rodzaje prowadnic

SKB RI

PP 60/12, PP 60/17
PPA 35/12, PPA 35/17
PPD 60/12, PPD 60/17
PPD-P 60/12, PPD-P 60/17
PPDA 60/12, PPDA 60/17
PPDA-P 60/12, PPDA-P 60/17
PPDMW 60/12, PPDMW 60/17
PPDMW-P 60/12, PPDMW-P 60/17

SKB RA

APPRA 45, APPDRA 79
PPRA/12, PPRA/17
PPMRA/12, PPMRA/17

Możliwości konfiguracji zestawu rolet o różnej wysokości

Zestaw okno - drzwi (w jednej skrzynce)

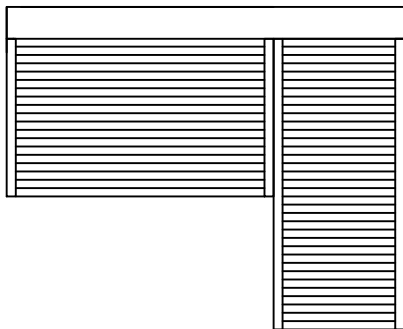

Rodzaje prowadnic

SKB RI

PP 60/12, PP 60/17
PPA 35/12, PPA 35/17
PPD 60/12, PPD 60/17
PPDA 60/12, PPDA 60/17
PPDMW 60/12, PPDMW 60/17

SKB RA

APPRA 45,
PPRA/12, PPRA/17
PPMRA/12, PPMRA/17

Zestaw okno - drzwi (w osobnych skrzynkach)

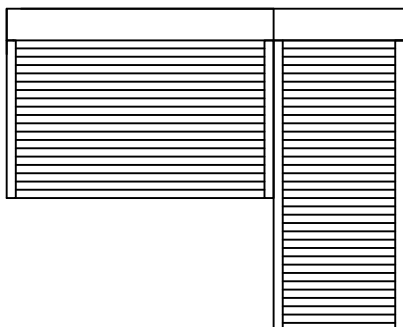

Rodzaje prowadnic

SKB RI

PP 60/12, PP 60/17
PPA 35/12, PPA 35/17
PPD 60/12, PPD 60/17
PPDA 60/12, PPDA 60/17
PPDMW 60/12, PPDMW 60/17

SKB RA

APPRA 45, APPDRA 79
PPRA/12, PPRA/17
PPMRA/12, PPMRA/17

Zestaw rolet o jednakowej wysokości (w jednej skrzynce) oraz drzwi (w osobnej skrzynce)

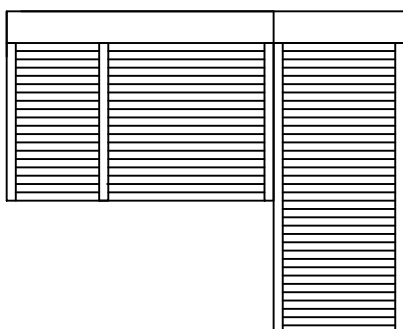

Rodzaje prowadnic

SKB RI

PP 60/12, PP 60/17
PPA 35/12, PPA 35/17
PPD 60/12, PPD 60/17
PPD-P 60/12, PPD-P 60/17
PPDA 60/12, PPDA 60/17
PPDA-P 60/12, PPDA-P 60/17
PPDMW 60/12, PPDMW 60/17
PPDMW-P 60/12, PPDMW-P 60/17

SKB RA

APPRA 45, APPDRA 79
PPRA/12, PPRA/17
PPMRA/12, PPMRA/17

Profile roletowe

Skala 1:1

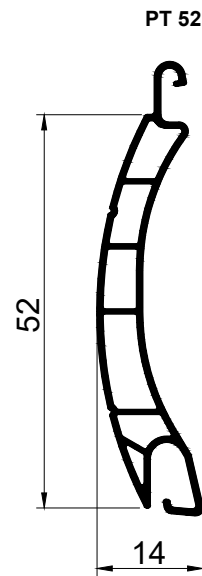
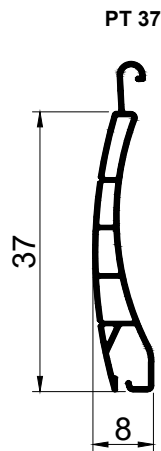
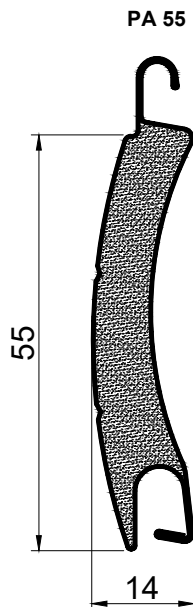
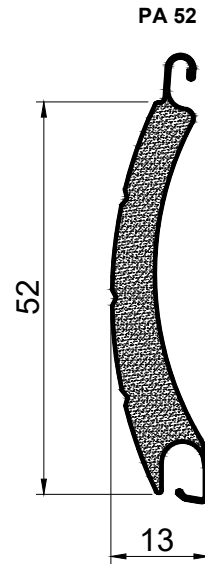
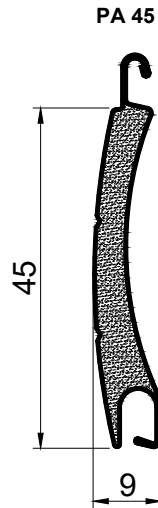
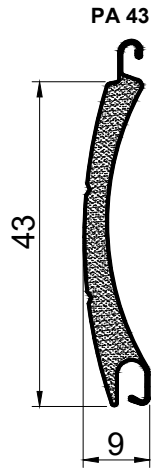
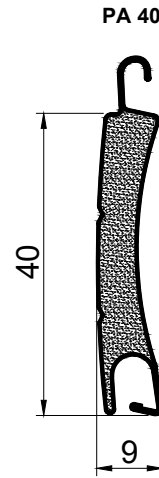
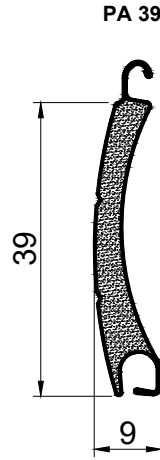
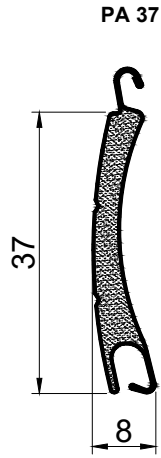

Profile skrzynki adaptacyjne

Skala 1:1

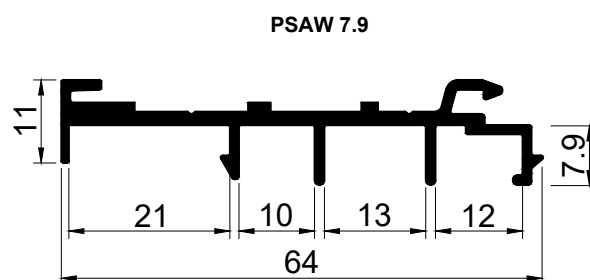
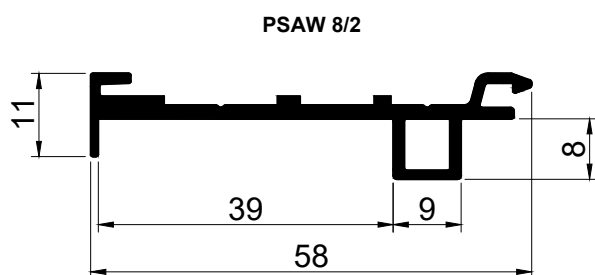
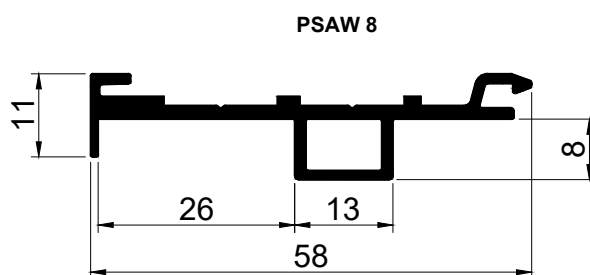
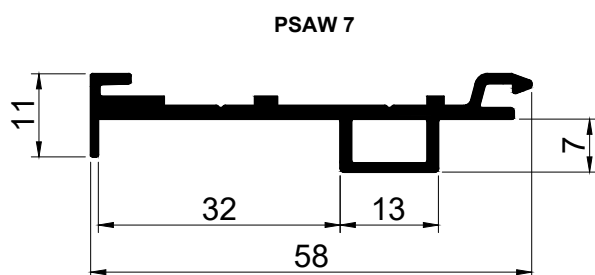
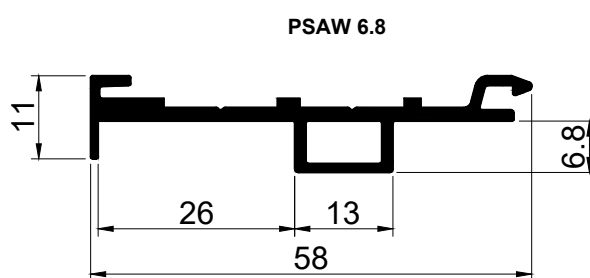
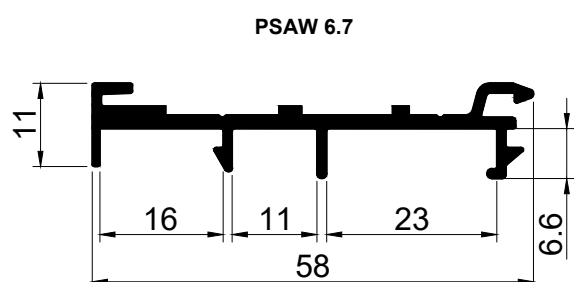
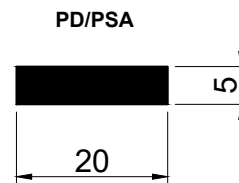
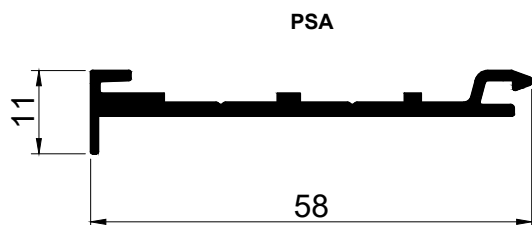

Prowadnice

Skala 1:2

SKB RI

PPA 35/12

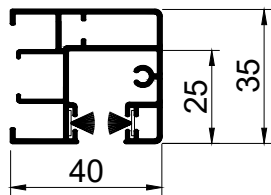

uszczelka
szczotkowa

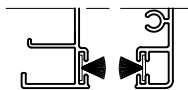

PPA 35/17

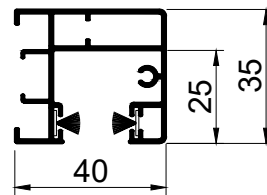

uszczelka
szczotkowa

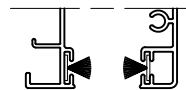

PP 60/12

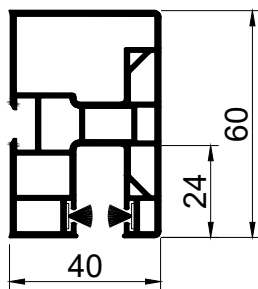

uszczelka
szczotkowa

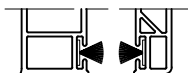

PP 60/17

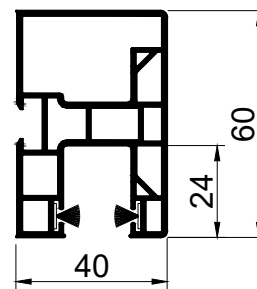

uszczelka
szczotkowa

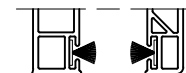

SKB RI

PPD 60/12

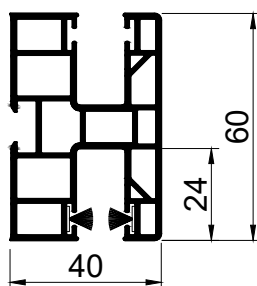

uszczelka
szczotkowa

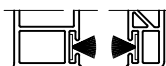

PPD 60/17

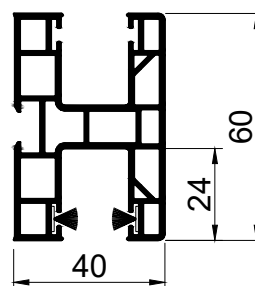

uszczelka
szczotkowa



PPD-P 60/12

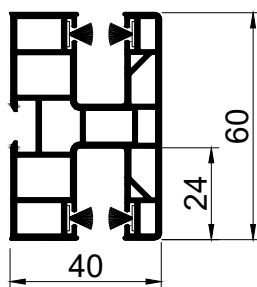

uszczelka
szczotkowa

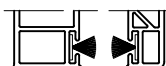

PPD-P 60/17

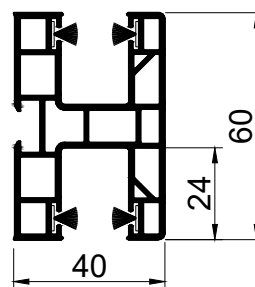

uszczelka
szczotkowa



Prowadnice

Skala 1:2

SKB RI

PPDA 60/12

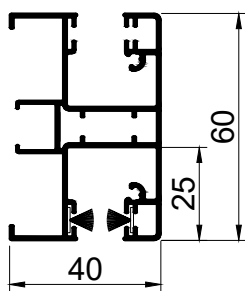
uszczelka
szczotkowa

PPDA 60/17

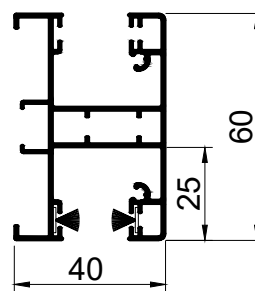
uszczelka
szczotkowa

PPDA-P 60/12

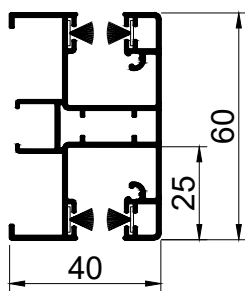
uszczelka
szczotkowa

PPDA-P 60/17

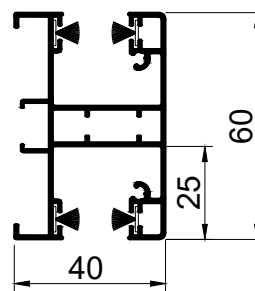
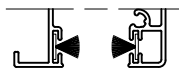
uszczelka
szczotkowa

SKB RI

PPDMW 60/12

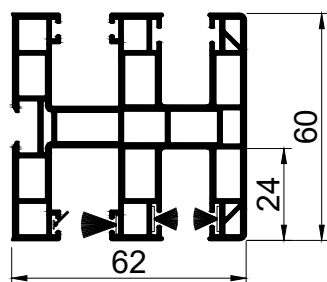

PPDMW 60/17

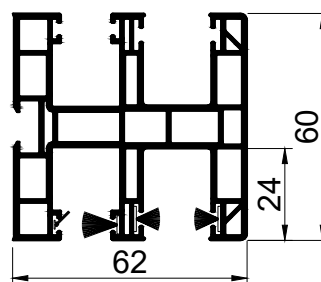

uszczelka
szczotkowa



uszczelka
szczotkowa



PPDMW-P 60/12

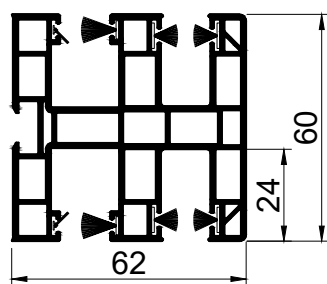

PPDMW-P 60/17

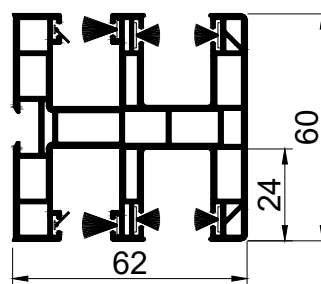

uszczelka
szczotkowa



uszczelka
szczotkowa



Prowadnice

Skala 1:2

SKB RA

APPRA 45

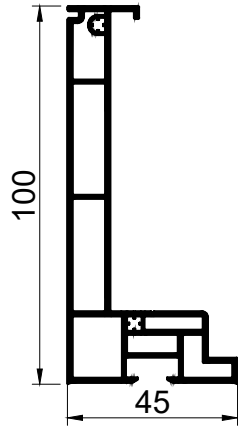

APPDRA 79

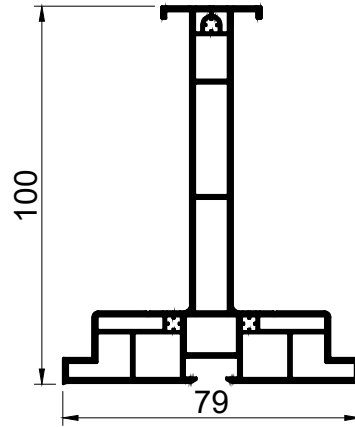

PPRA/12

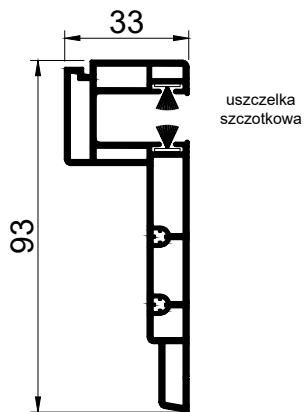

PPRA/17

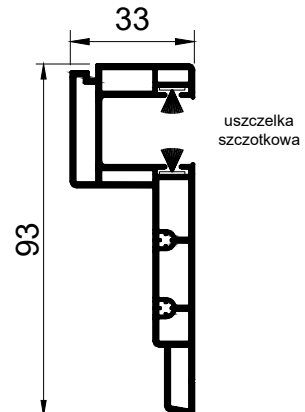

PPMRA/12

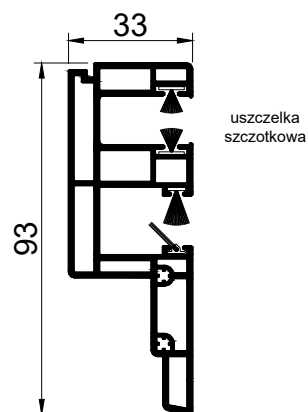

PPMRA/17

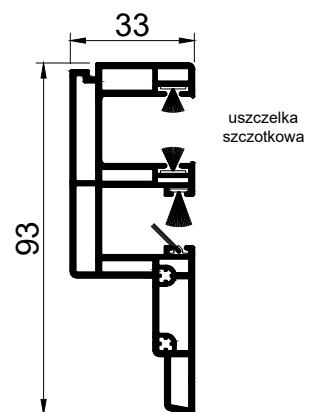

SKB F

APPF/B 33

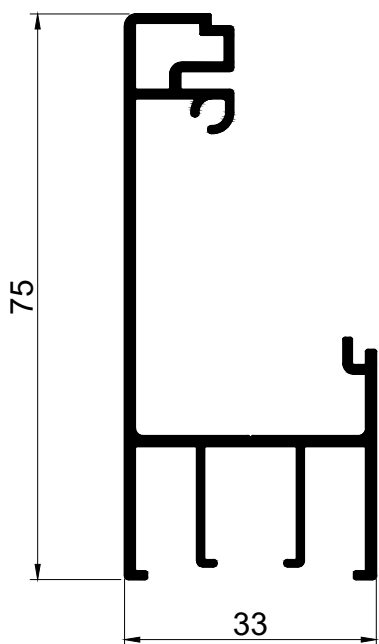

PPF

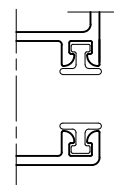
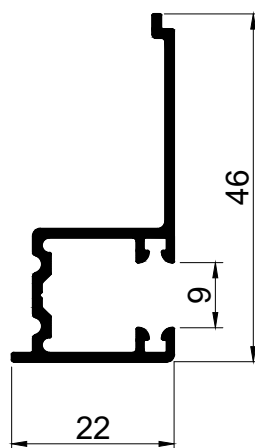

uszczelka gumowa

PPZ 32 MZN

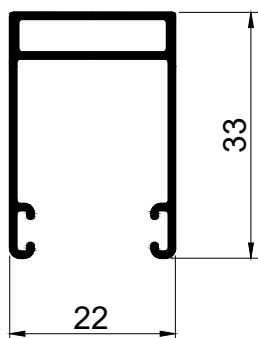

uszczelka
szczotkowa

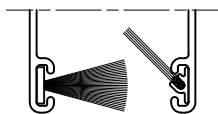

uszczelka
szczotkowa

Listwy dolne

Skala 1:1

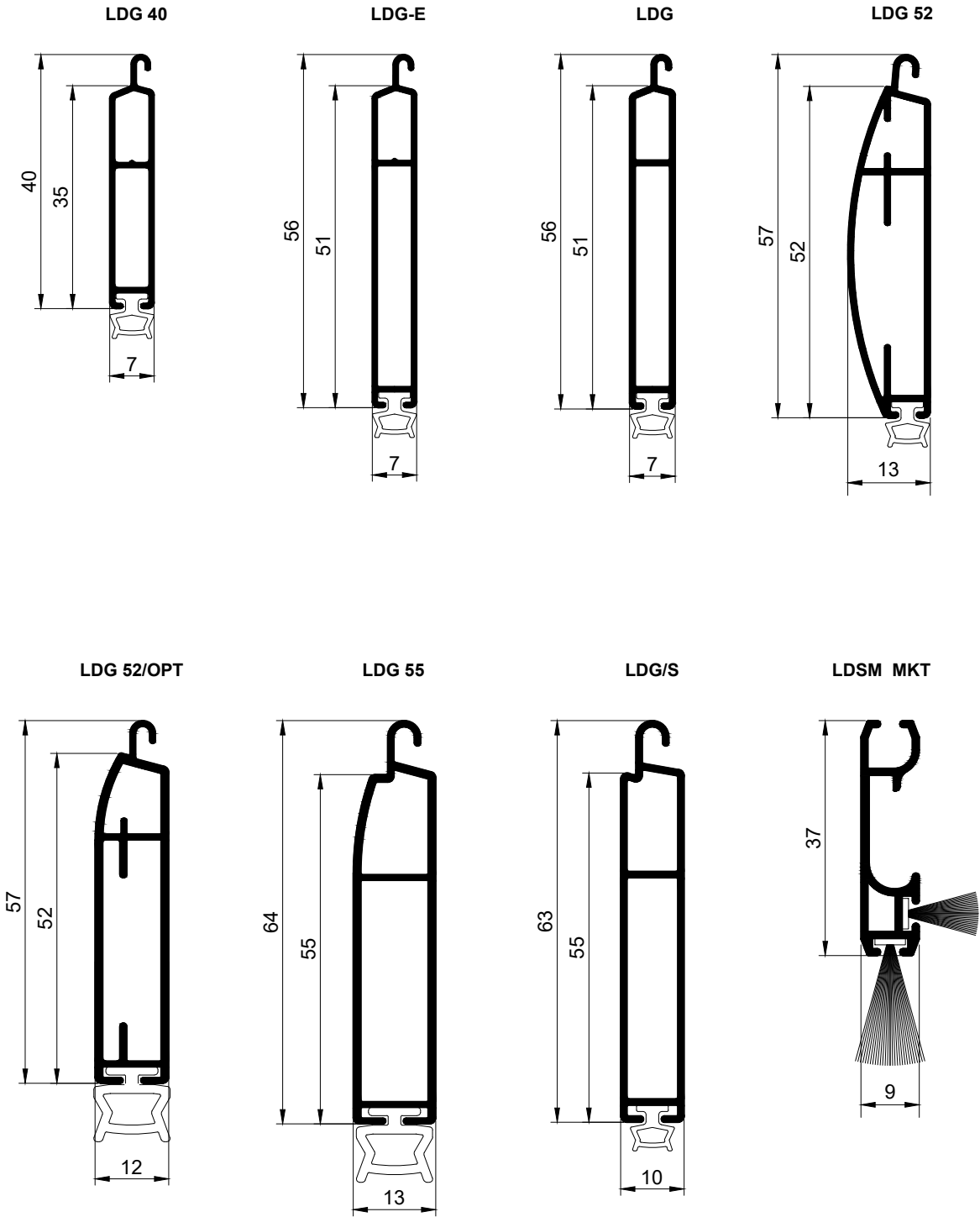

Skrzynki i pokrywy boczne

Skala 1:4

SKB/260/RI

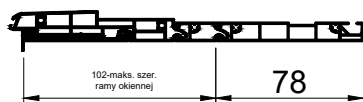
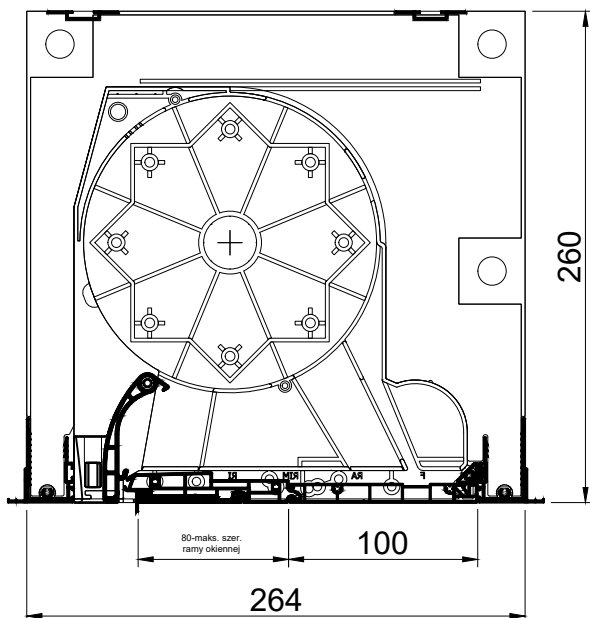

SKB/300/RI

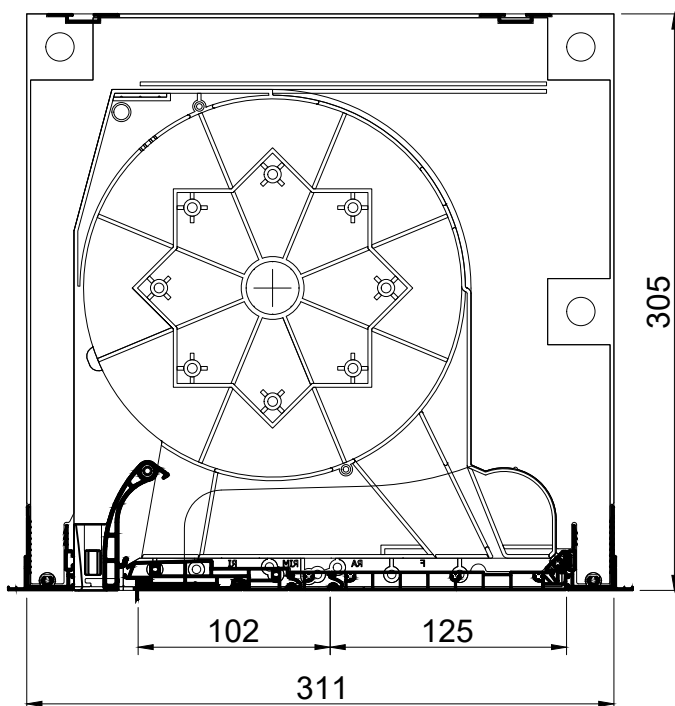

Skrzynki i pokrywy boczne

Skala 1:4

SKB/260/RA

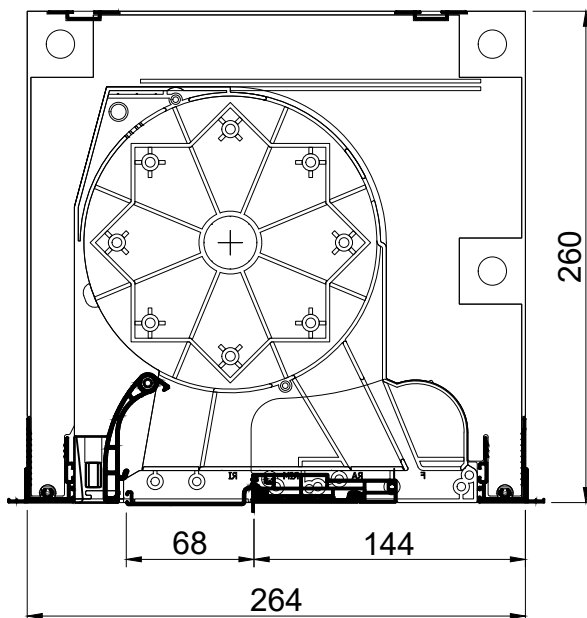

SKB/300/RA

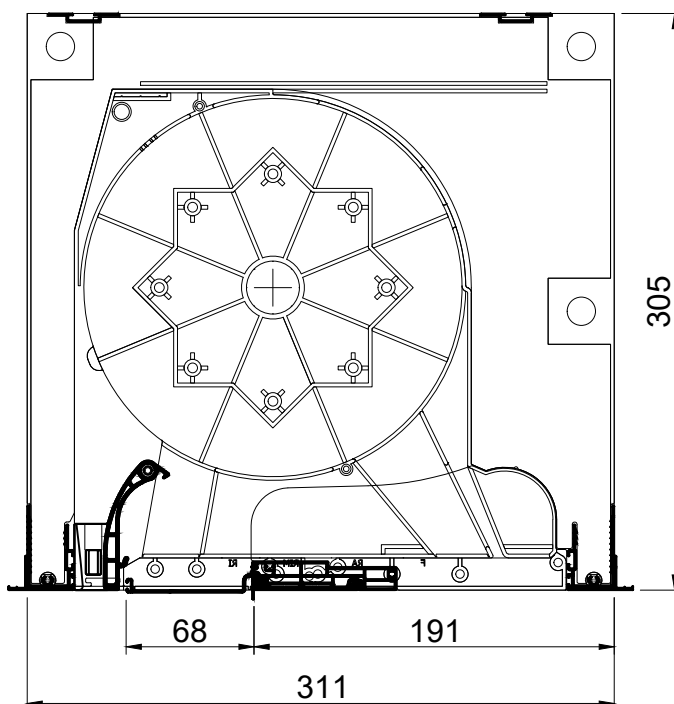

Skrzynki i pokrywy boczne

Skala 1:4

SKB/260/F

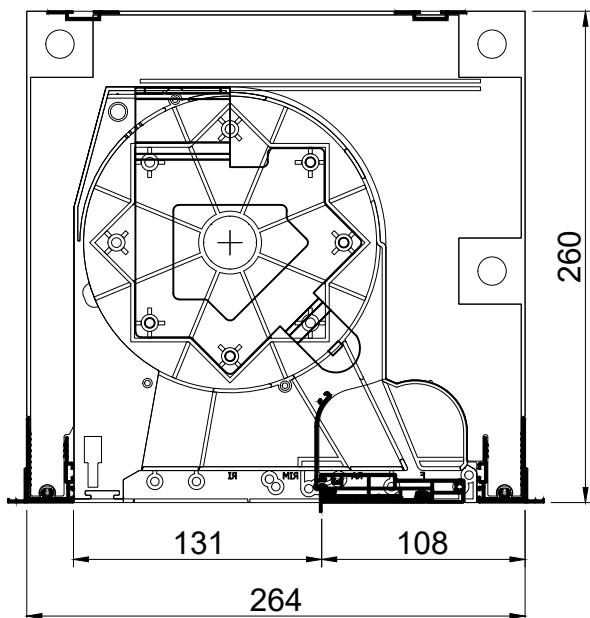

SKB/300/F

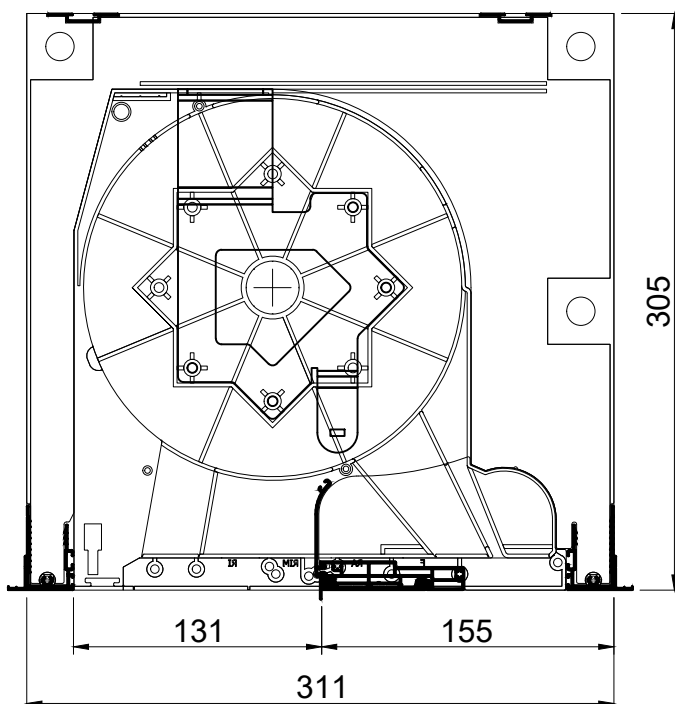

Skrzynki i pokrywy boczne

Skala 1:4

SKB/260/RI + MKT

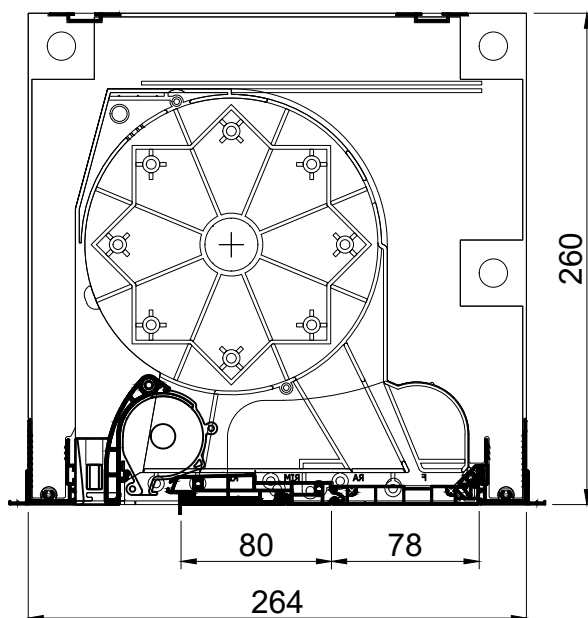

SKB/300/RI + MKT

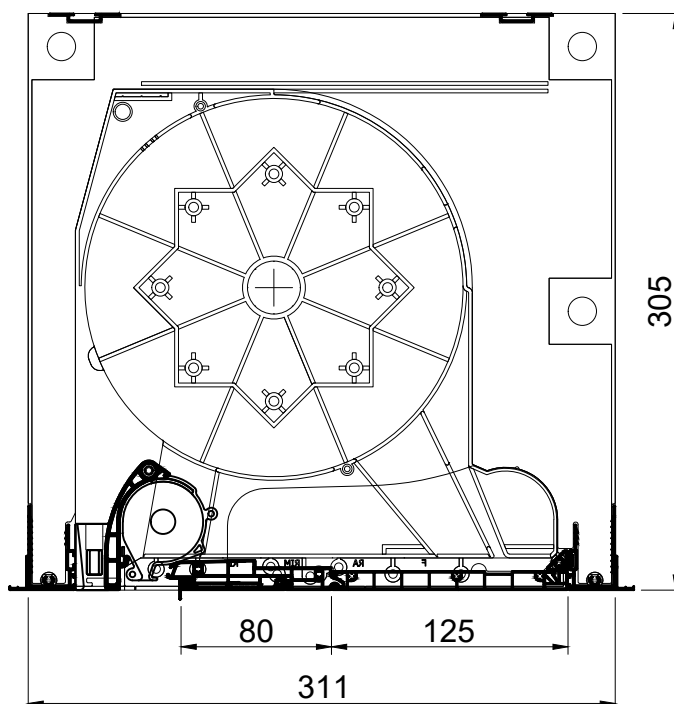

Skrzynki i pokrywy boczne

Skala 1:4

SKB/260/RA + MKT

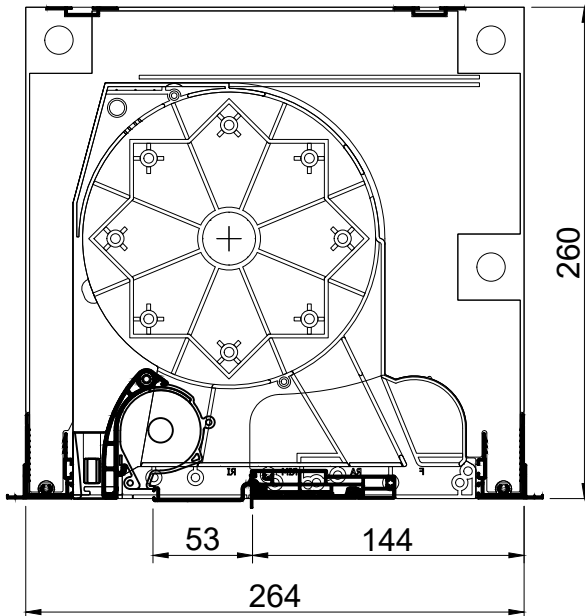

SKB/300/RA + MKT

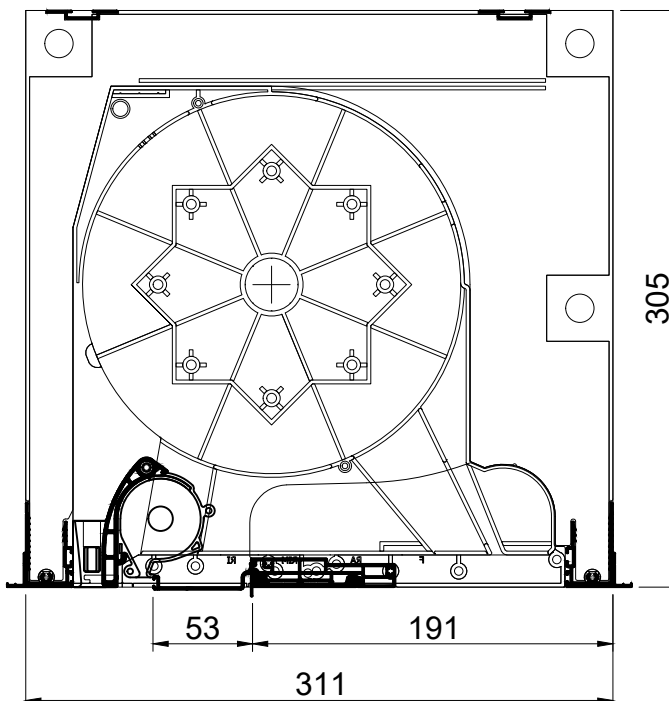

Skrzynki i pokrywy boczne

Skala 1:4

SKB/260/F + MKT

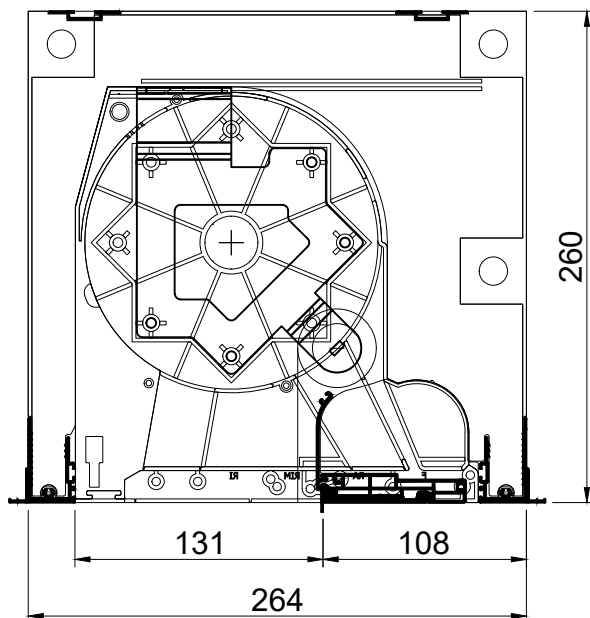

SKB/300/F + MKT

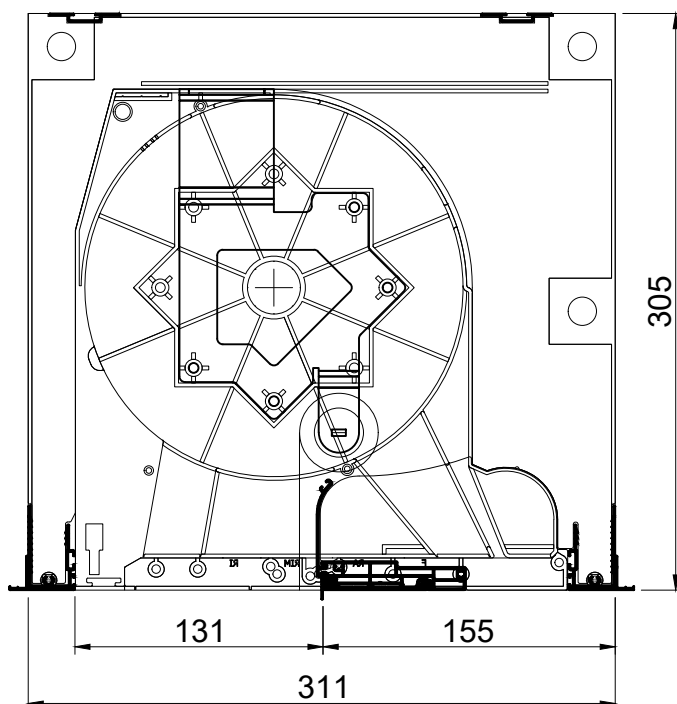

Rolety - przykłady zabudowy

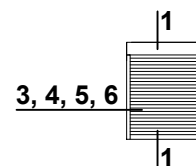

Skala 1:6

1 SKB/260/R/

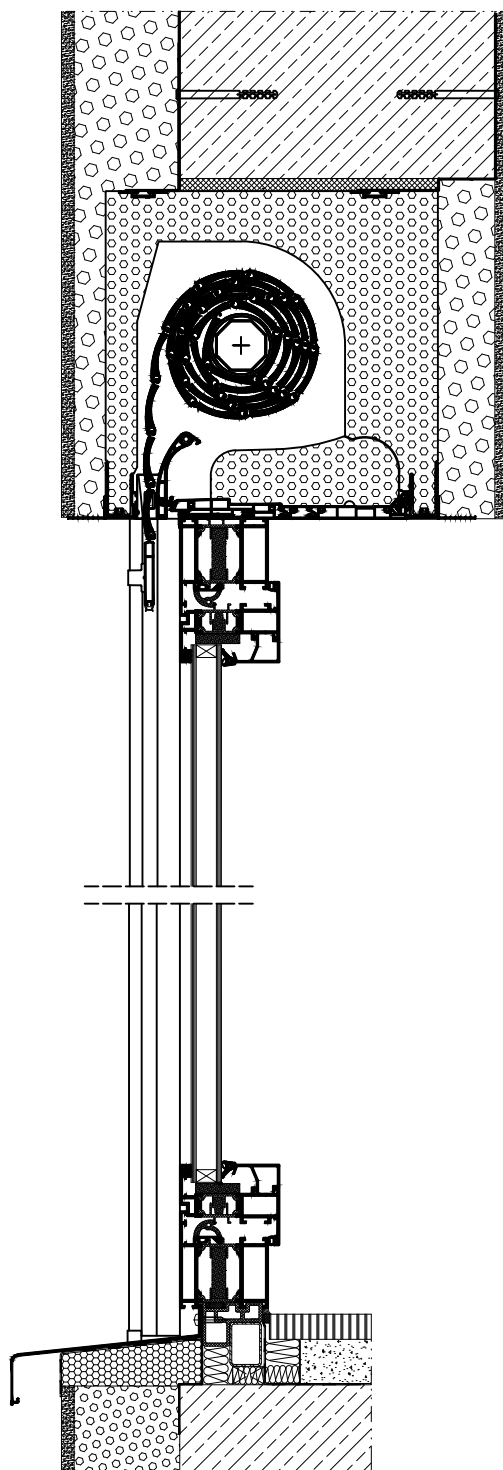

Rolety - przykłady zabudowy

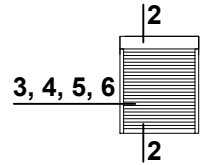

Skala 1:6

2 SKB/260/R/

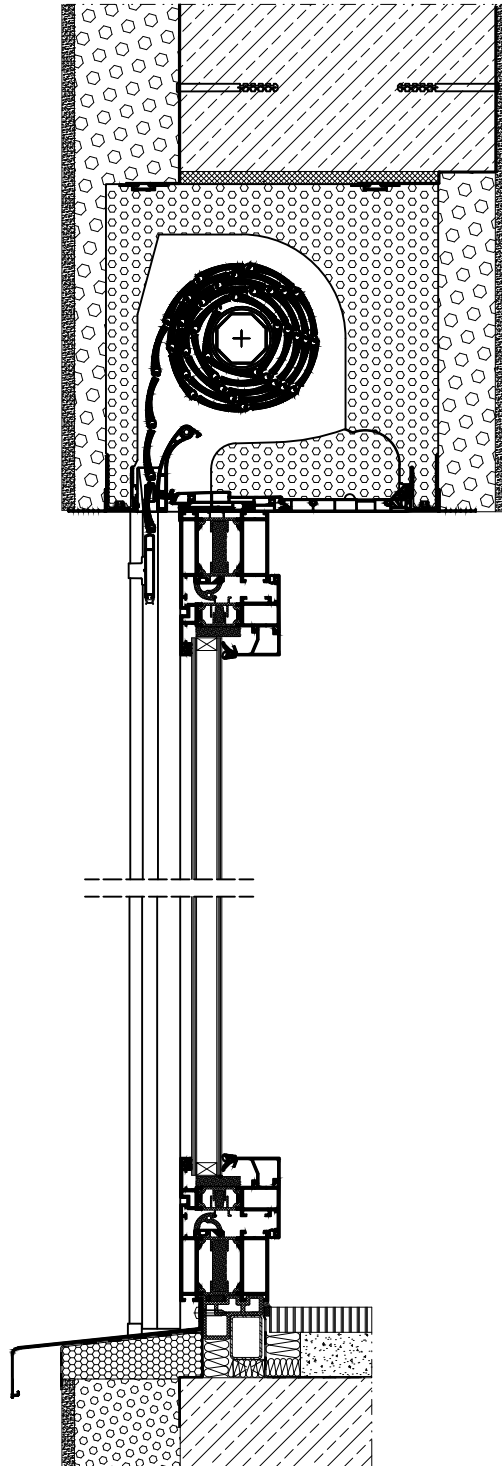

Rolety - przykłady zabudowy

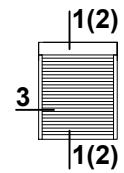

Skala 1:4

3 SKB/260/R1

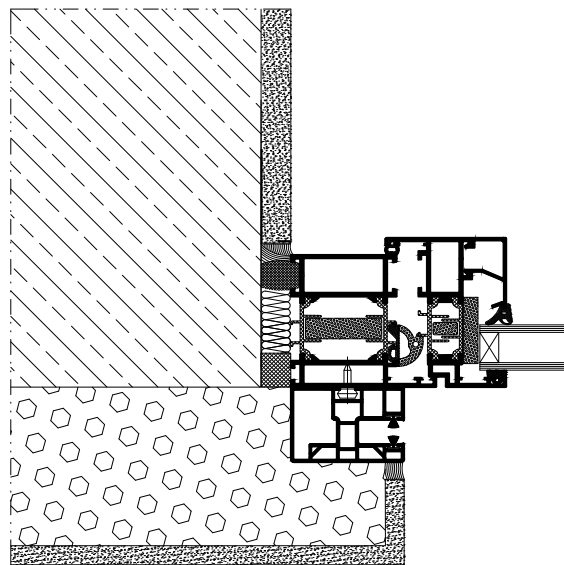

Rolety - przykłady zabudowy

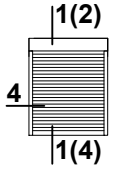

Skala 1:4

4 SKB/260/R/

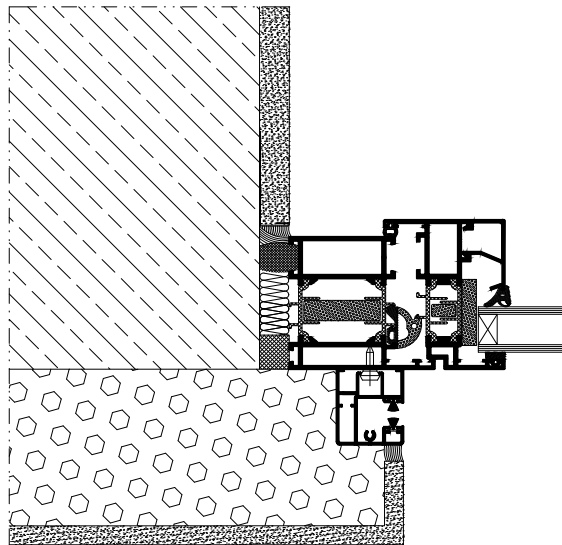

Rolety - przykłady zabudowy

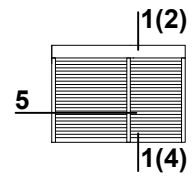

Skala 1:4

5 SKB/260/R/

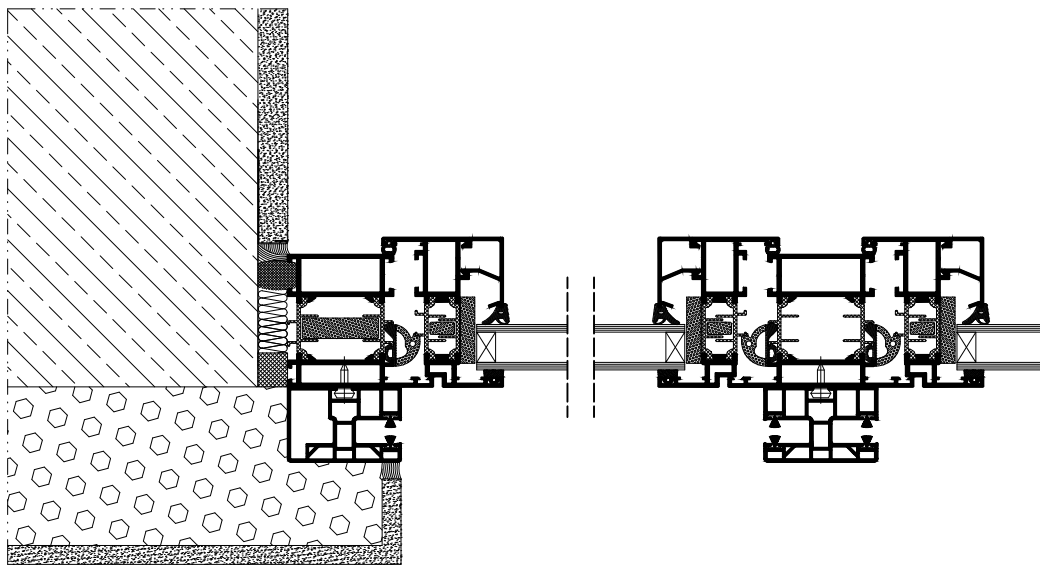

Rolety - przykłady zabudowy

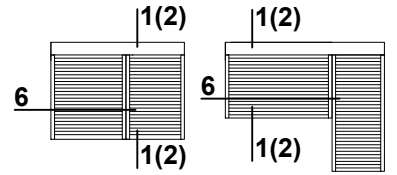

Skala 1:4

6 SKB/260/R/

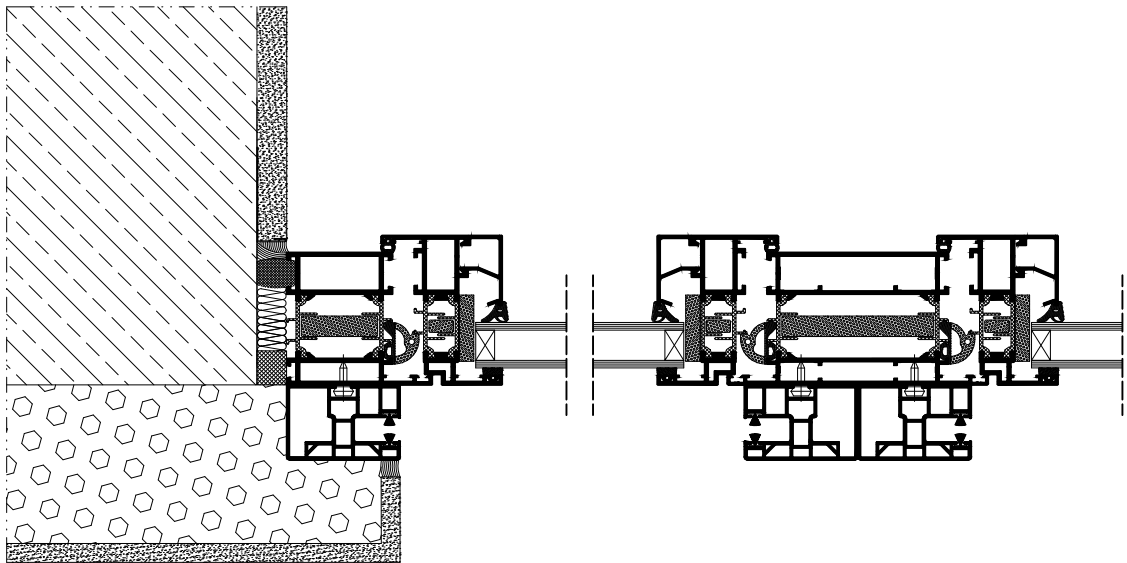

Rolety - przykłady zabudowy

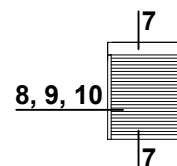

Skala 1:6

7 SKB/260/RA

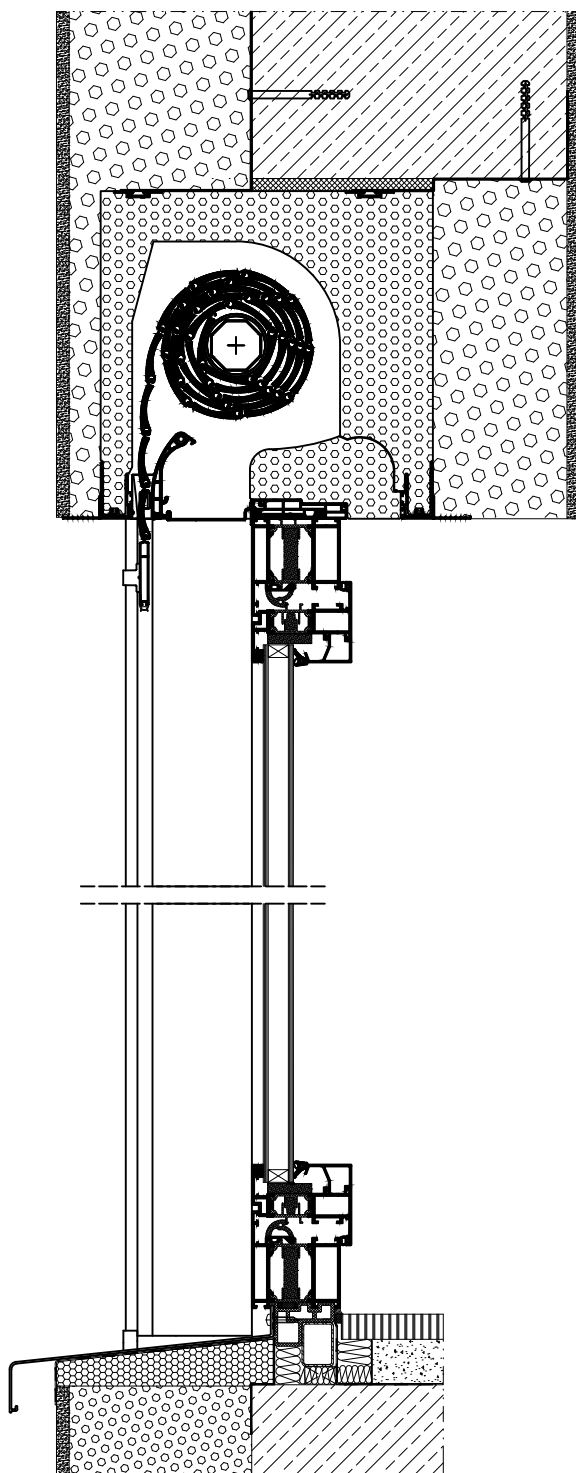

Rolety - przykłady zabudowy

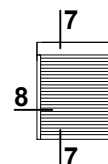

Skala 1:4

8 SKB/260/RA

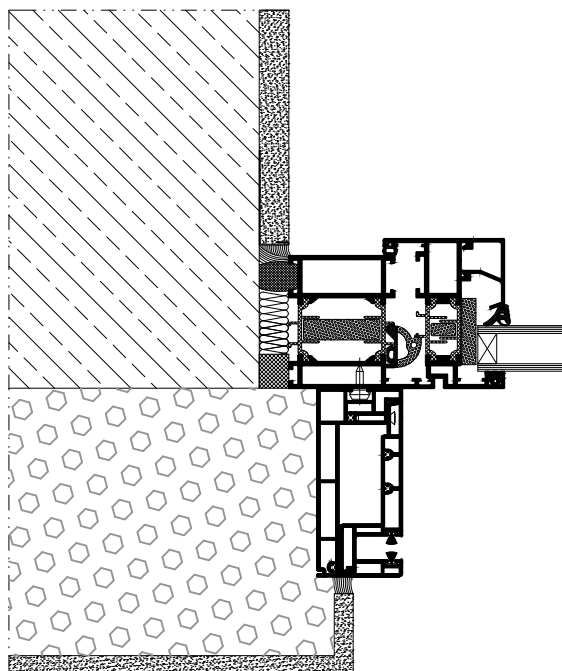

Rolety - przykłady zabudowy

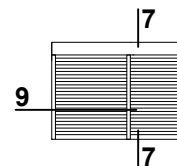

Skala 1:4

9 SKB/260/RA

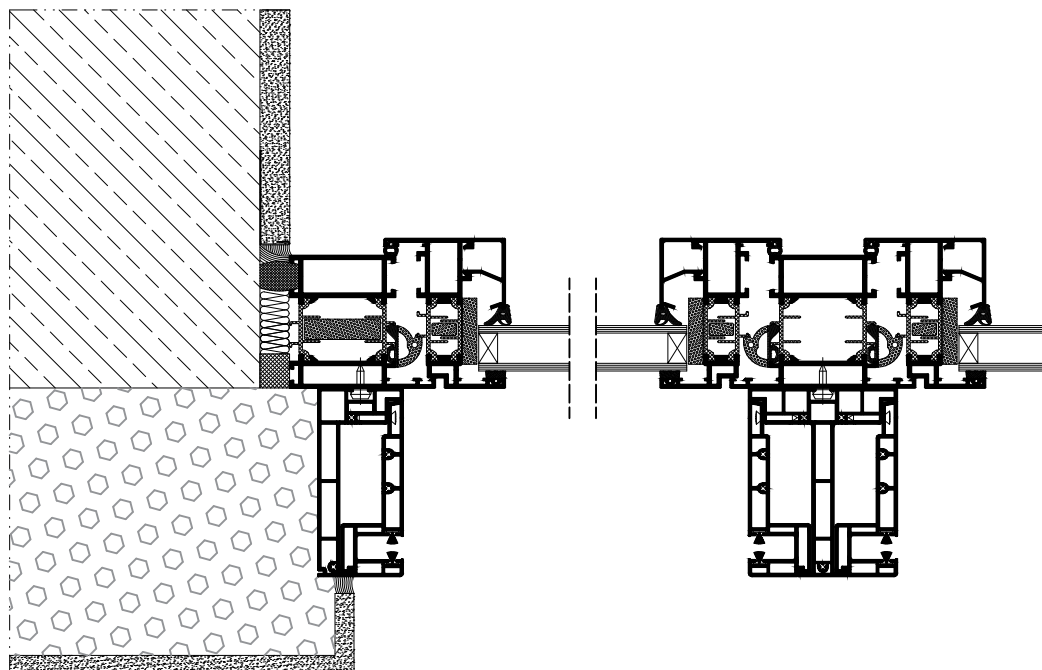

Rolety - przykłady zabudowy

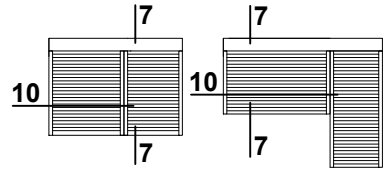

Skala 1:4

10 | SKB/260/RA

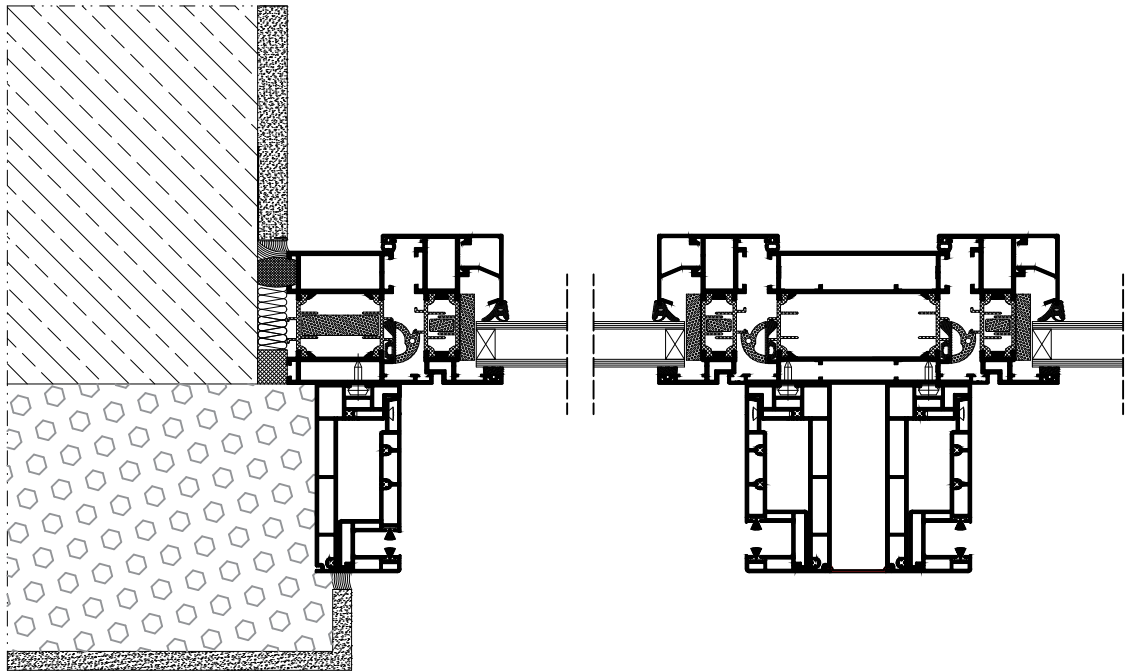

Rolety - przykłady zabudowy

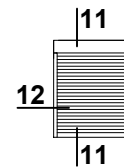

Skala 1:6

11 SKB/260/F

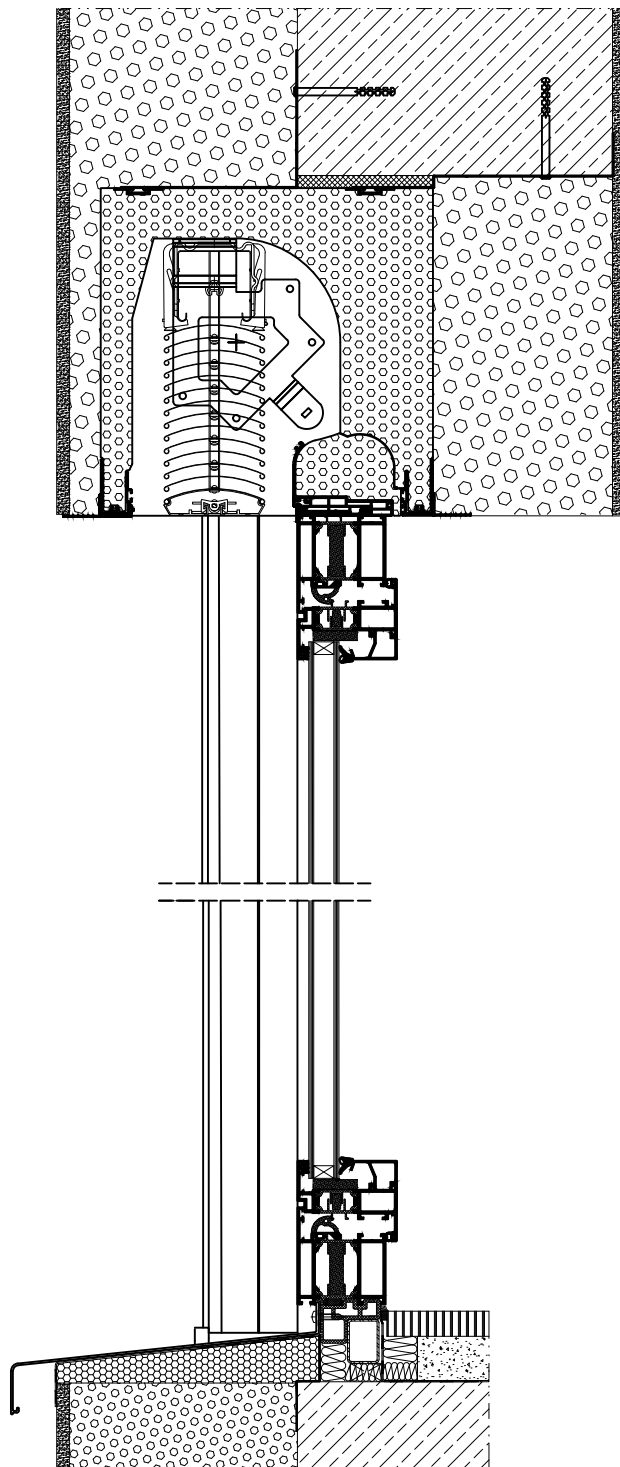

Rolety - przykłady zabudowy

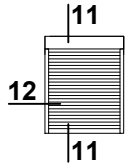

Skala 1:4

12 | SKB/260/F

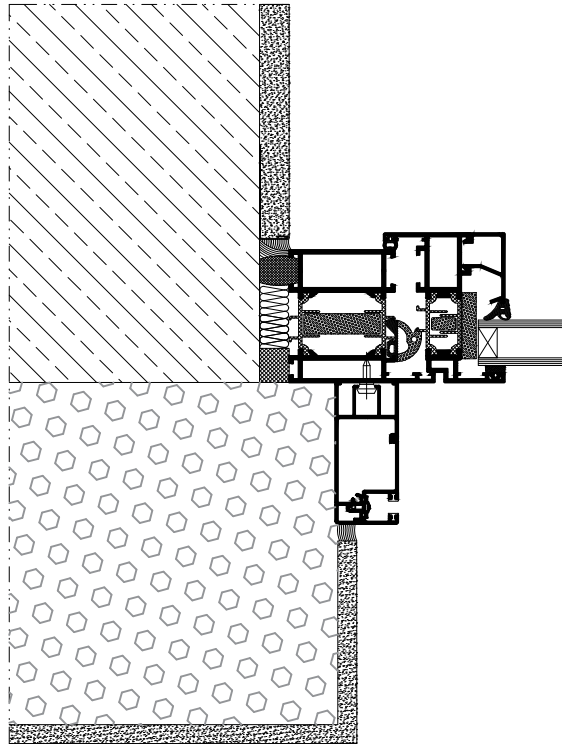

Rolety z moskitierą - przykłady zabudowy

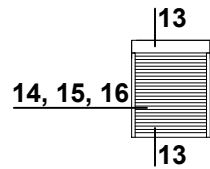

Skala 1:6

13 SKB/260/RI MKT

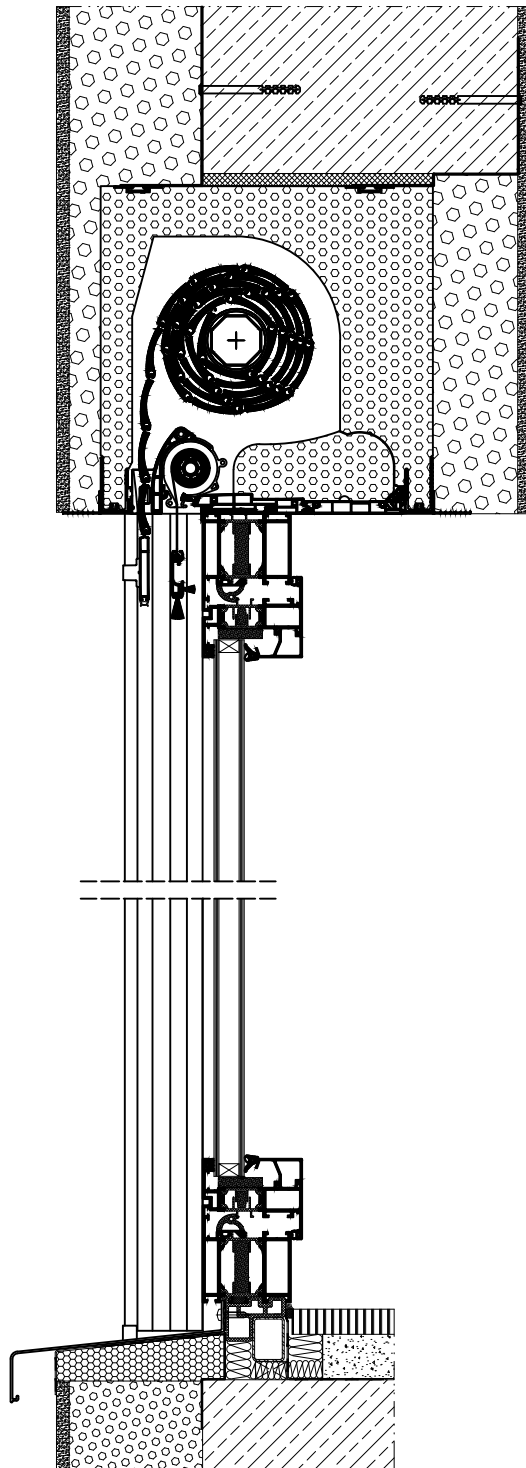

Rolety z moskitierą - przykłady zabudowy

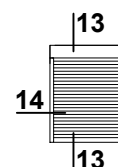

Skala 1:4

14 SKB/260/RI MKT

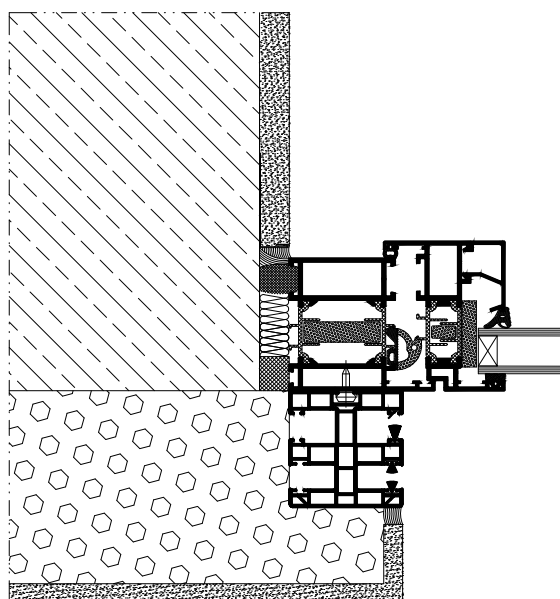

Rolety z moskitierą - przykłady zabudowy

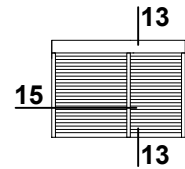

Skala 1:4

15 SKB/260/RI MKT

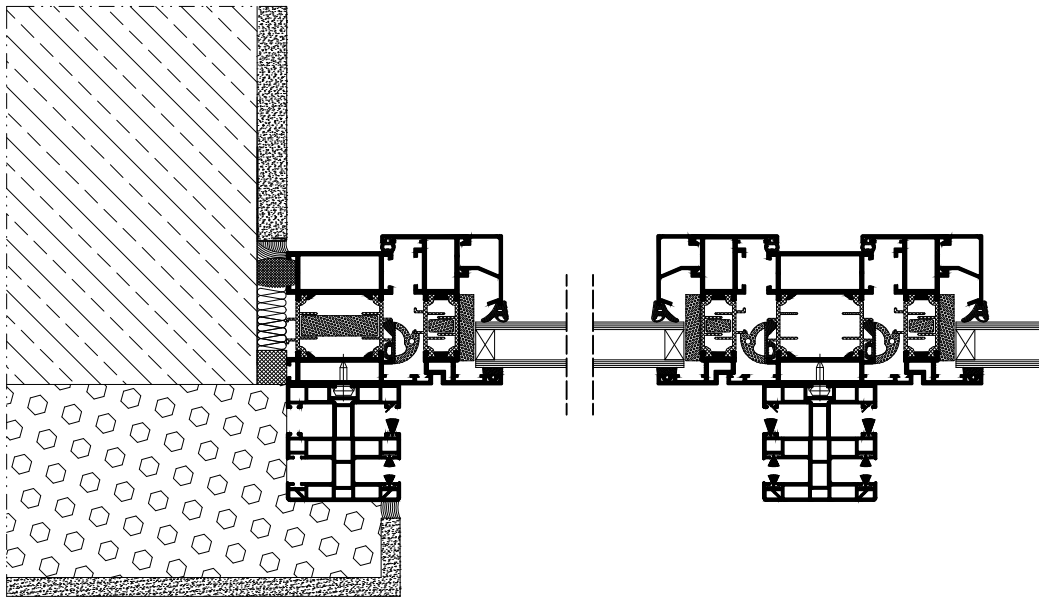

Rolety z moskitierą - przykłady zabudowy

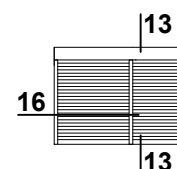

Skala 1:4

16 | SKB/260/RI MKT

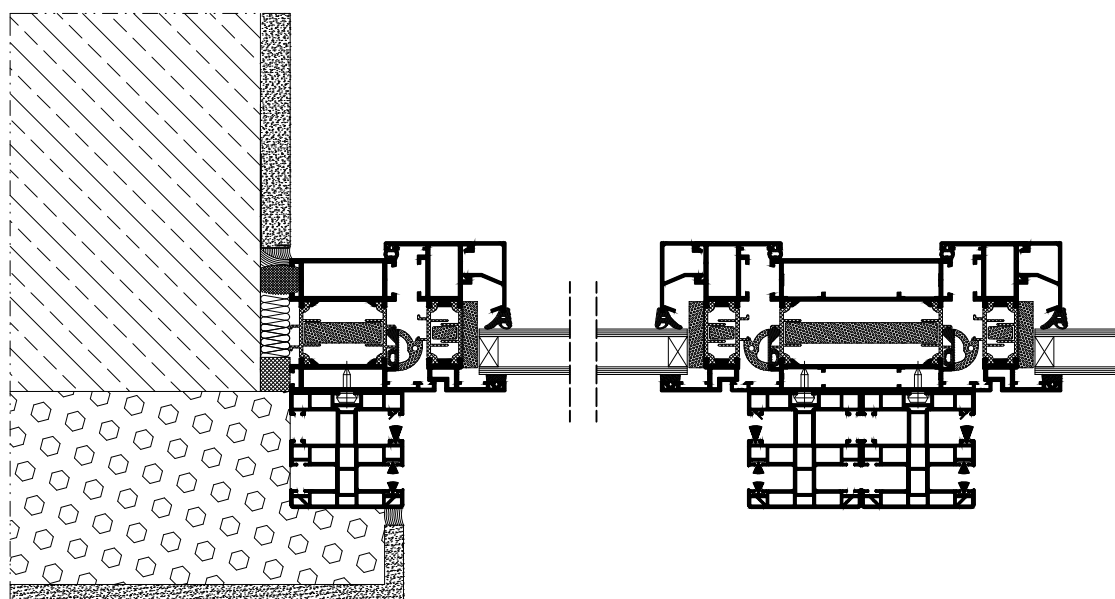

Rolety z moskitierą - przykłady zabudowy

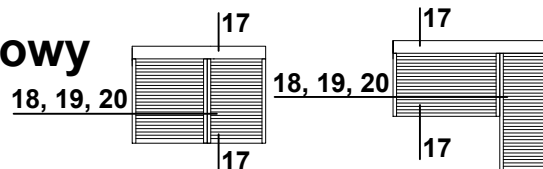

17 SKB/260/RA MKT

Skala 1:6

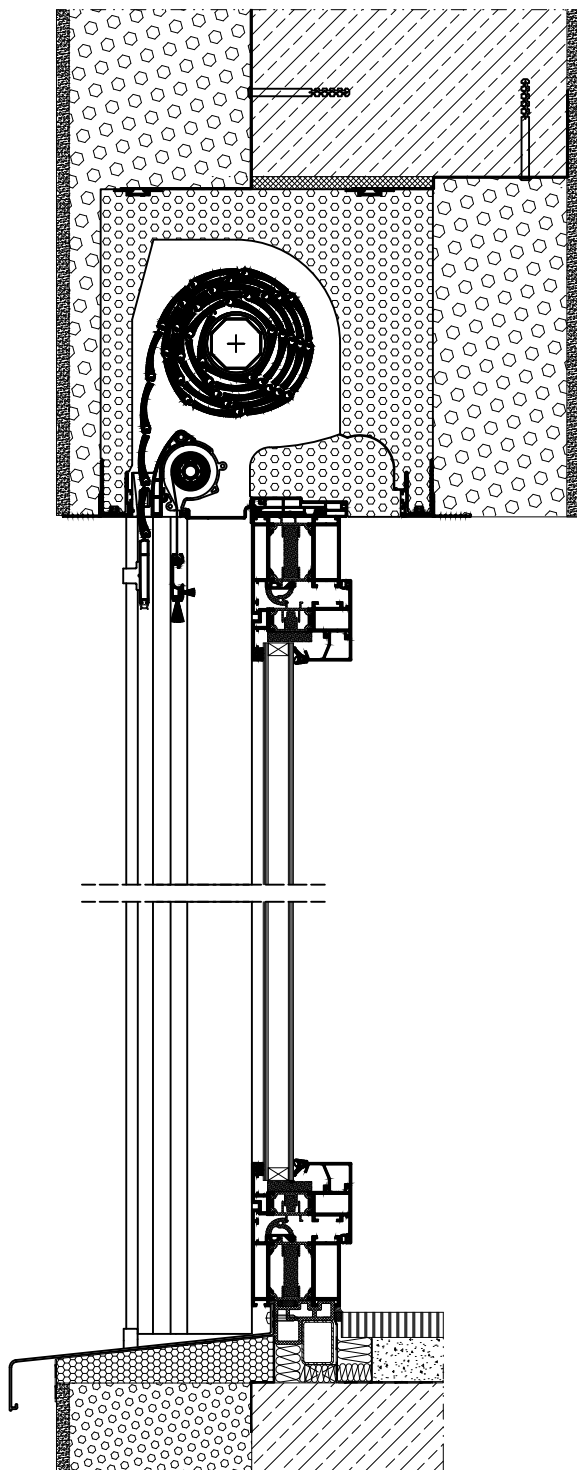

Rolety z moskitierą - przykłady zabudowy

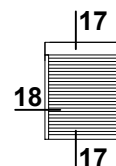

Skala 1:4

18 | SKB/260/RA MKT

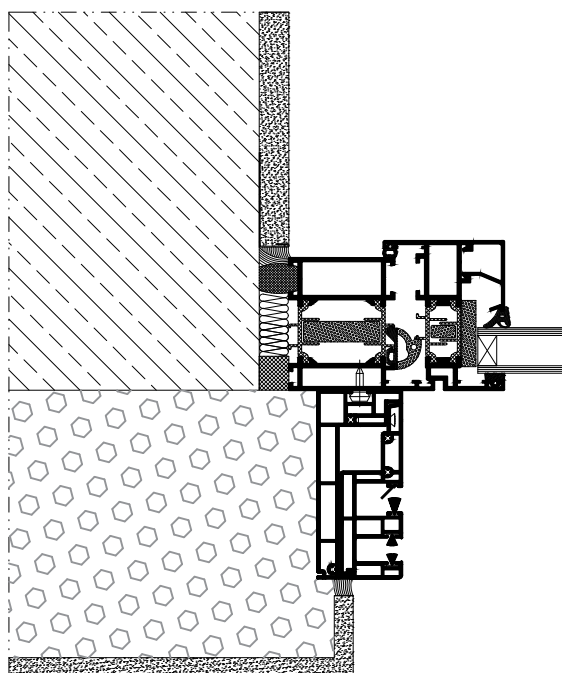

Rolety z moskitierą - przykłady zabudowy

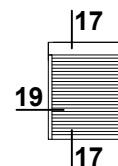

Skala 1:4

19 SKB/260/RA MKT

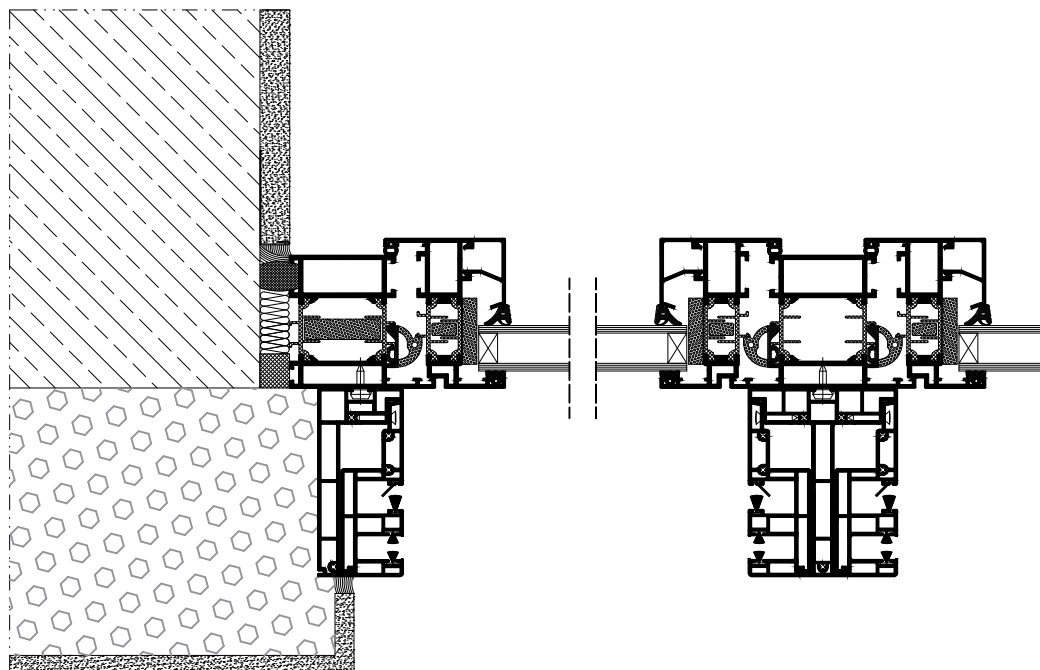

Rolety z moskitierą - przykłady zabudowy

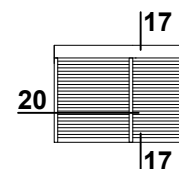

Skala 1:4

20 | SKB/260/RA MKT

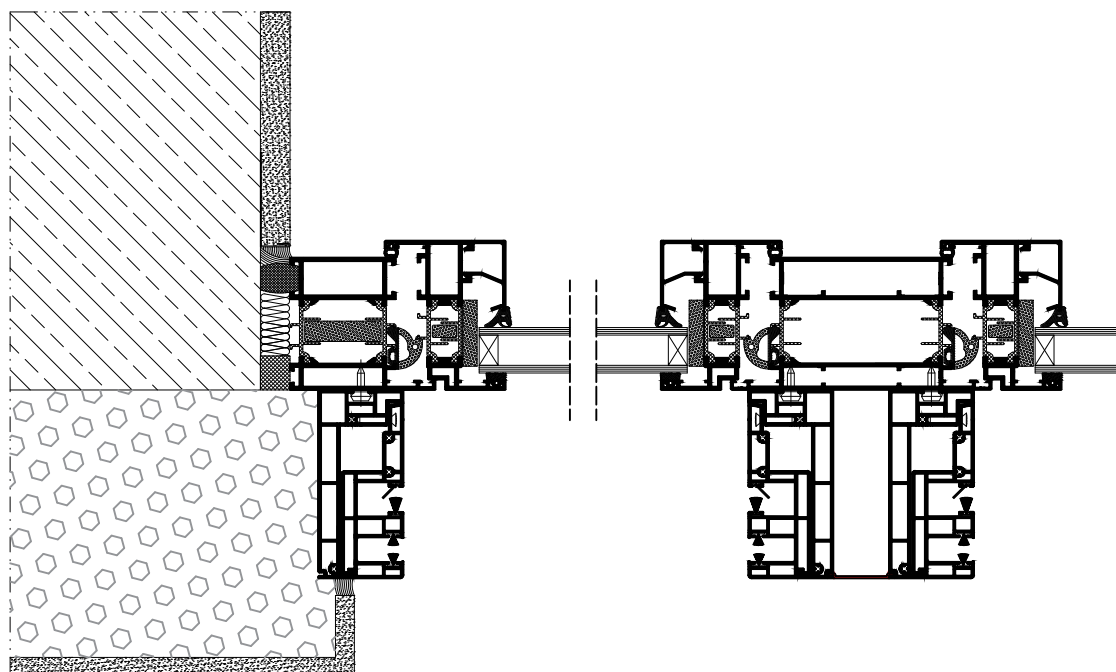

Rolety z moskitierą - przykłady zabudowy

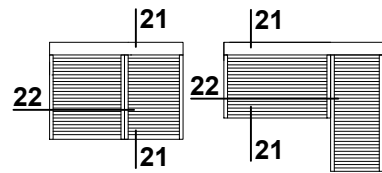

21 SKB/260/F MKT

Skala 1:6

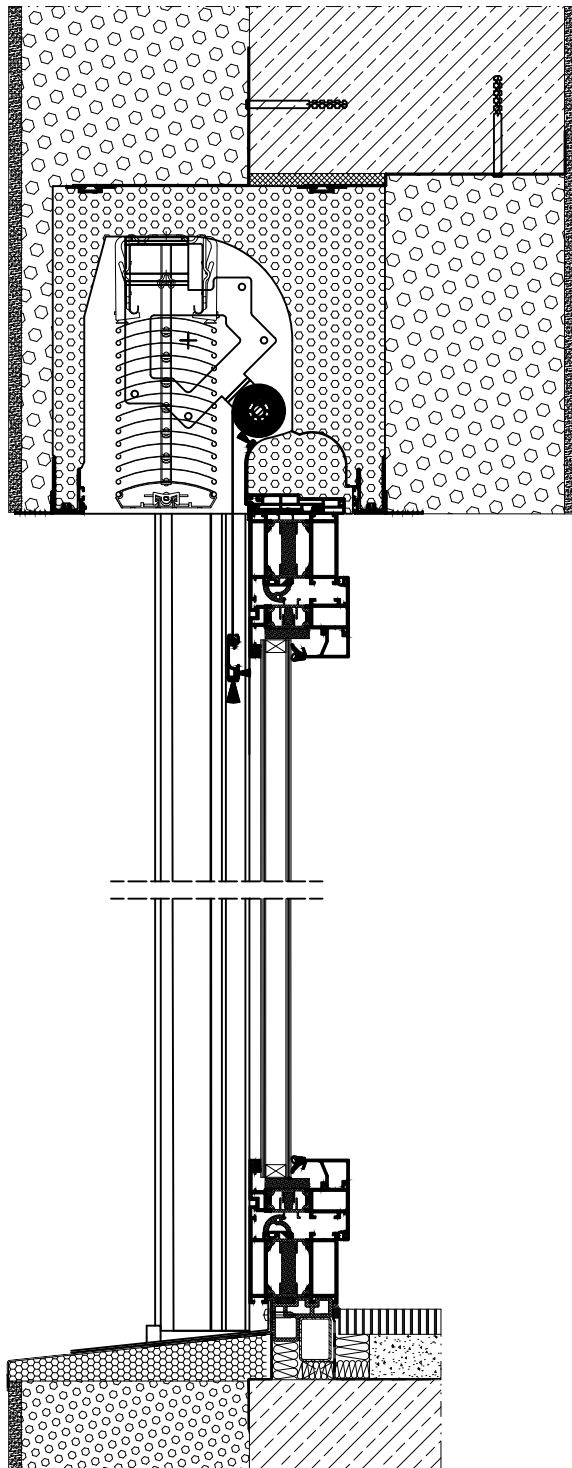

Rolety z moskitierą - przykłady zabudowy

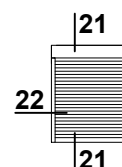

Skala 1:4

22 | SKB/260/F MKT

