

Oznaczenie katalogowe systemu

Tytuł rysunku

MPH

Moskitiery - przykłady zabudowy

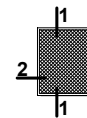

Piktogram (oznaczenie przekroju)

Skala 1:4

Skala rysunku

1 MPH - 01

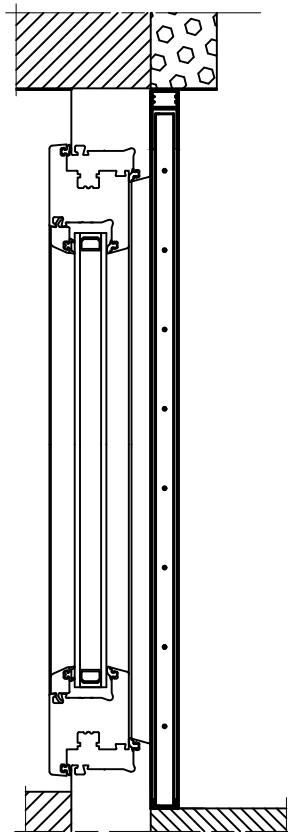

Data aktualizacji

06/2018



MPH / 03

Numer strony

Numer przekroju (zgodny z piktogramem)

Wariant przekroju

1 MPH - 01

System

Maksymalne wymiary moskitier

MPH moskitiera plisowana - Harmony

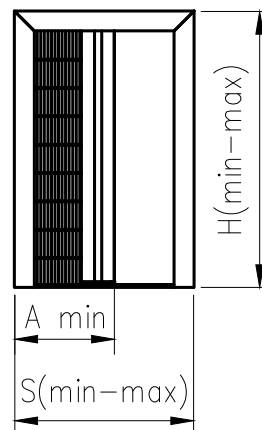
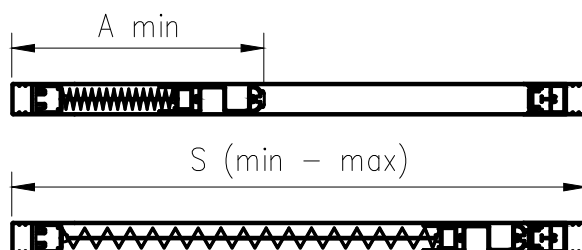

SET MPH/800/2300

Amin = 120 mm
Smin = 600 mm
Smax = 800 mm
Hmin = 1900 mm
Hmax = 2300 mm

SET MPH/1200/2300

Amin = 130 mm
Smin = 800 mm
Smax = 1200 mm
Hmin = 1900 mm
Hmax = 2300 mm

SET MPH/1200/2700

Amin = 130 mm
Smin = 800 mm
Smax = 1200 mm
Hmin = 2300 mm
Hmax = 2700 mm

SET MPH/1600/2300

Amin = 145 mm
Smin = 1200 mm
Smax = 1600 mm
Hmin = 1900 mm
Hmax = 2300 mm

SET MPH/1600/2700

Amin = 145 mm
Smin = 1200 mm
Smax = 1600 mm
Hmin = 2300 mm
Hmax = 2700 mm

SET MPH/2000/2300

Amin = 155 mm
Smin = 1600 mm
Smax = 2000 mm
Hmin = 1900 mm
Hmax = 2300 mm

SET MPH/2000/2700

Amin = 155 mm
Smin = 1600 mm
Smax = 2000 mm
Hmin = 2300 mm
Hmax = 2700 mm

SET MPH/2400/2300

Amin = 170 mm
Smin = 2000 mm
Smax = 2400 mm
Hmin = 1900 mm
Hmax = 2300 mm

SET MPH/2400/2700

Amin = 170 mm
Smin = 2000 mm
Smax = 2400 mm
Hmin = 2300 mm
Hmax = 2700 mm

SET MPH/3000/2300

Amin = 185 mm
Smin = 2400 mm
Smax = 3000 mm
Hmin = 1900 mm
Hmax = 2300 mm

SET MPH/3000/2700

Amin = 185 mm
Smin = 2400 mm
Smax = 3000 mm
Hmin = 2300 mm
Hmax = 2700 mm

SET MPH/4000/2300

Amin = 210 mm
Smin = 3000 mm
Smax = 4000 mm
Hmin = 1900 mm
Hmax = 2300 mm

SET MPH/4000/2700

Amin = 210 mm
Smin = 3000 mm
Smax = 4000 mm
Hmin = 2300 mm
Hmax = 2700 mm

MPH

Profile moskitier

MPH moskitiera plisowana - Harmony

Skala 1:1

PPR MPH

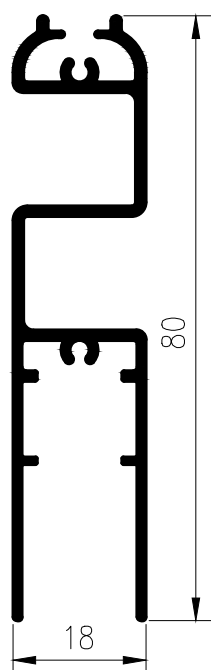

PP MPH

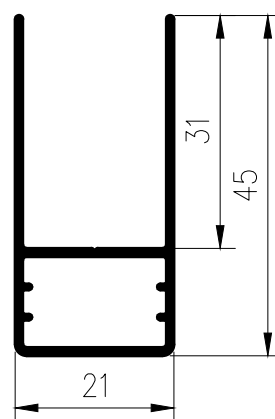

PD MPH

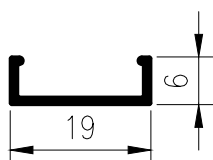

PDP MPH

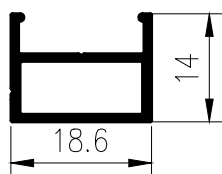

PDS MPH

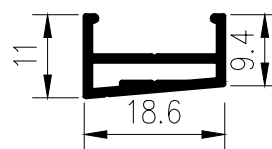

Moskitiery - przykłady zabudowy

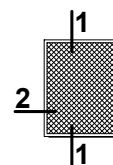

Skala 1:4

1 MPH - 01

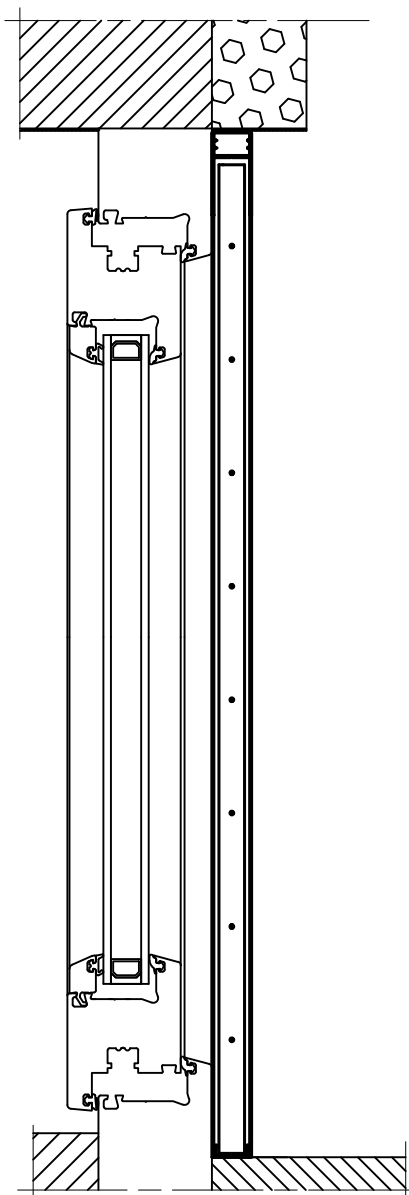

Moskitiery - przykłady zabudowy

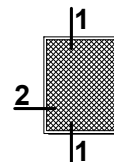

Skala 1:5

2 MPH - 01

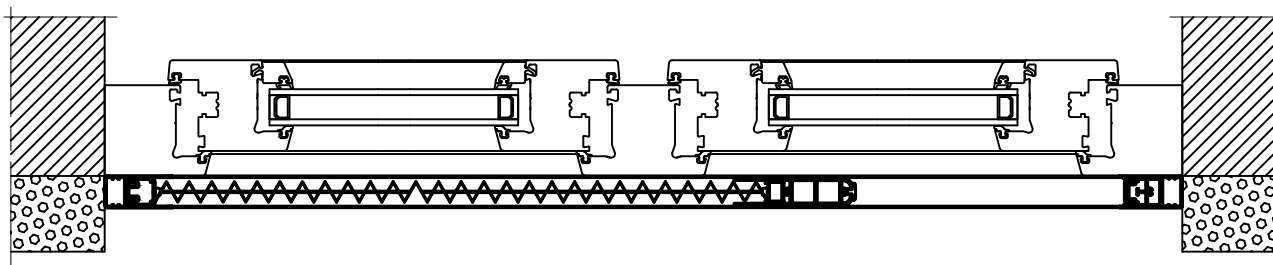

Moskitiery - przykłady zabudowy

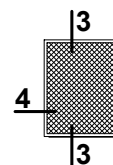

Skala 1:4

3 MPH - 02

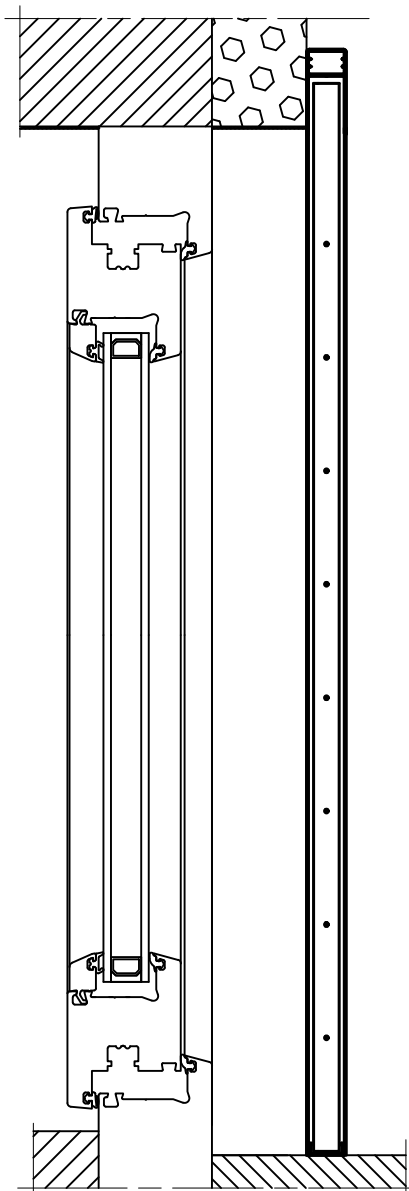

Moskitiery - przykłady zabudowy

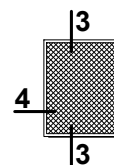

Skala 1:5

4 MPH - 02

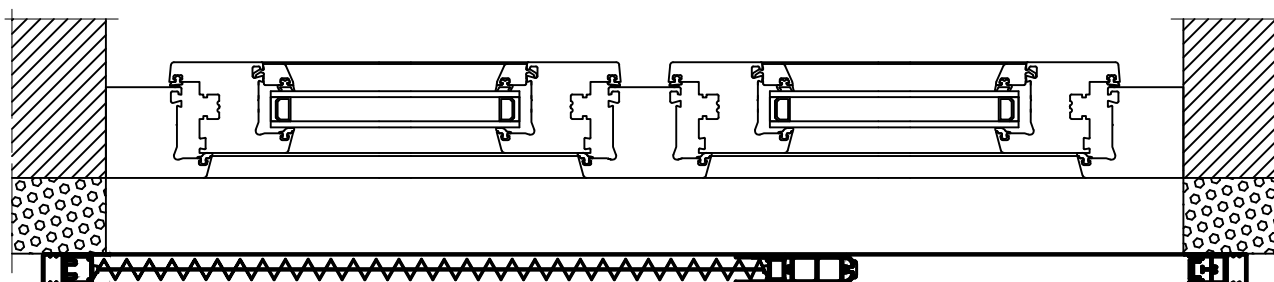

Moskitiery - przykłady zabudowy

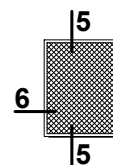

Skala 1:4

5 MPH - 03

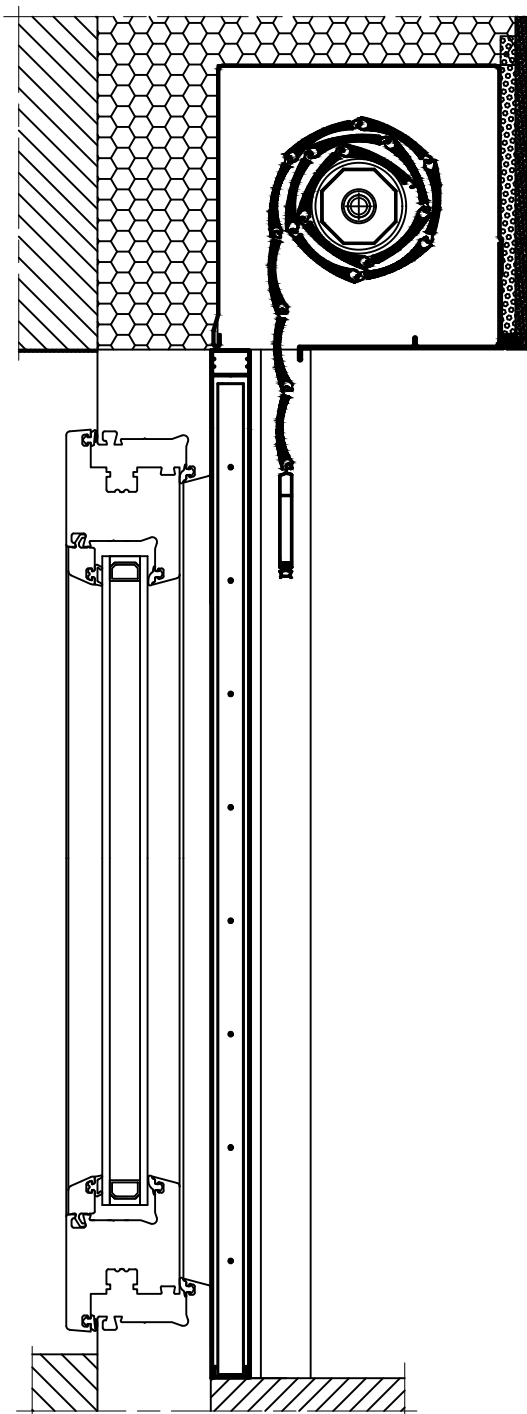

Moskitiery - przykłady zabudowy

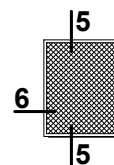

Skala 1:6

6 MPH - 03

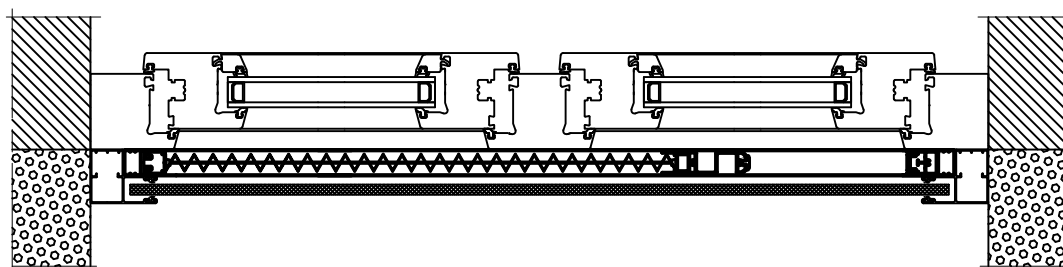

Moskitiery - przykłady zabudowy

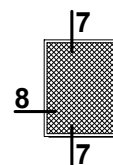

Skala 1:4

7 MPH - 04

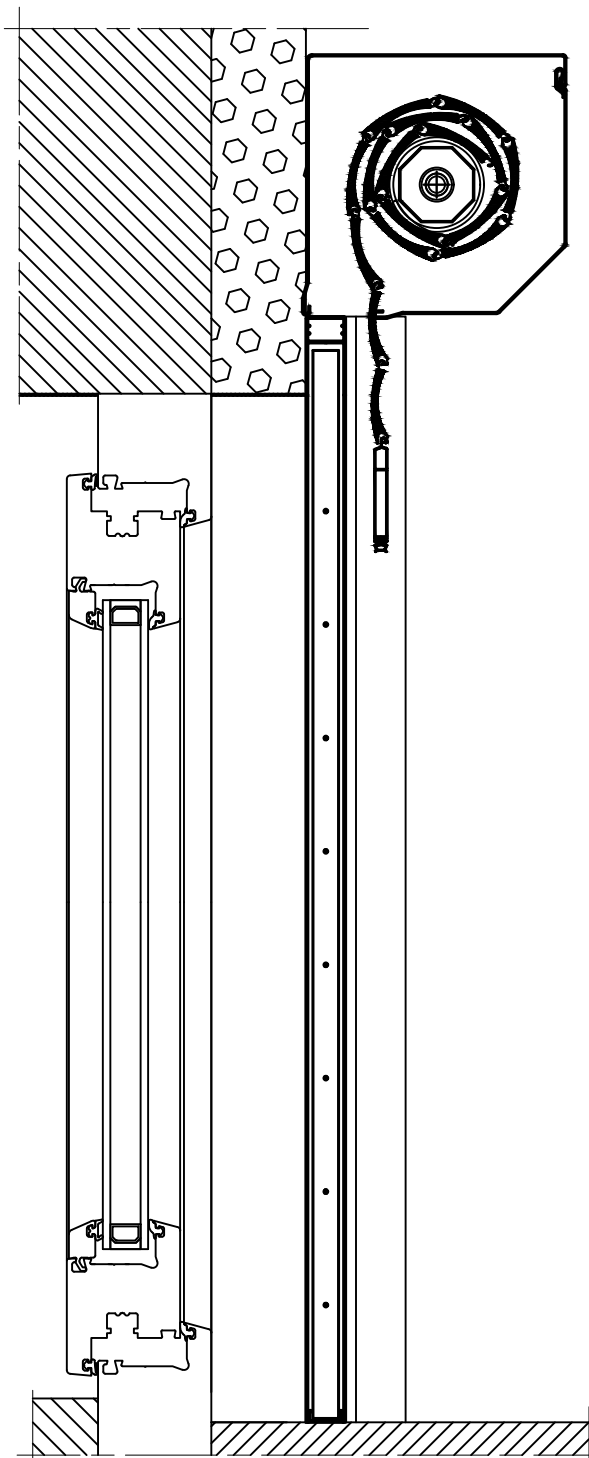

Moskitiery - przykłady zabudowy

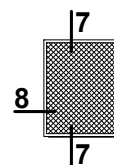

Skala 1:6

8 MPH - 04

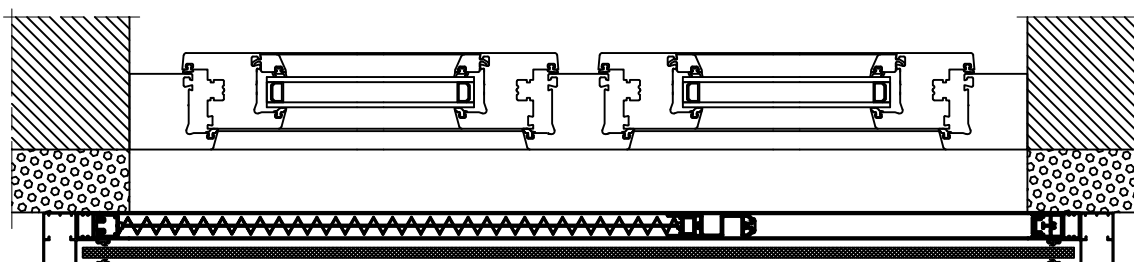

Moskitiery - przykłady zabudowy

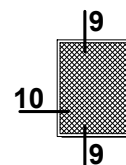

Skala 1:4

9 MPH - 05

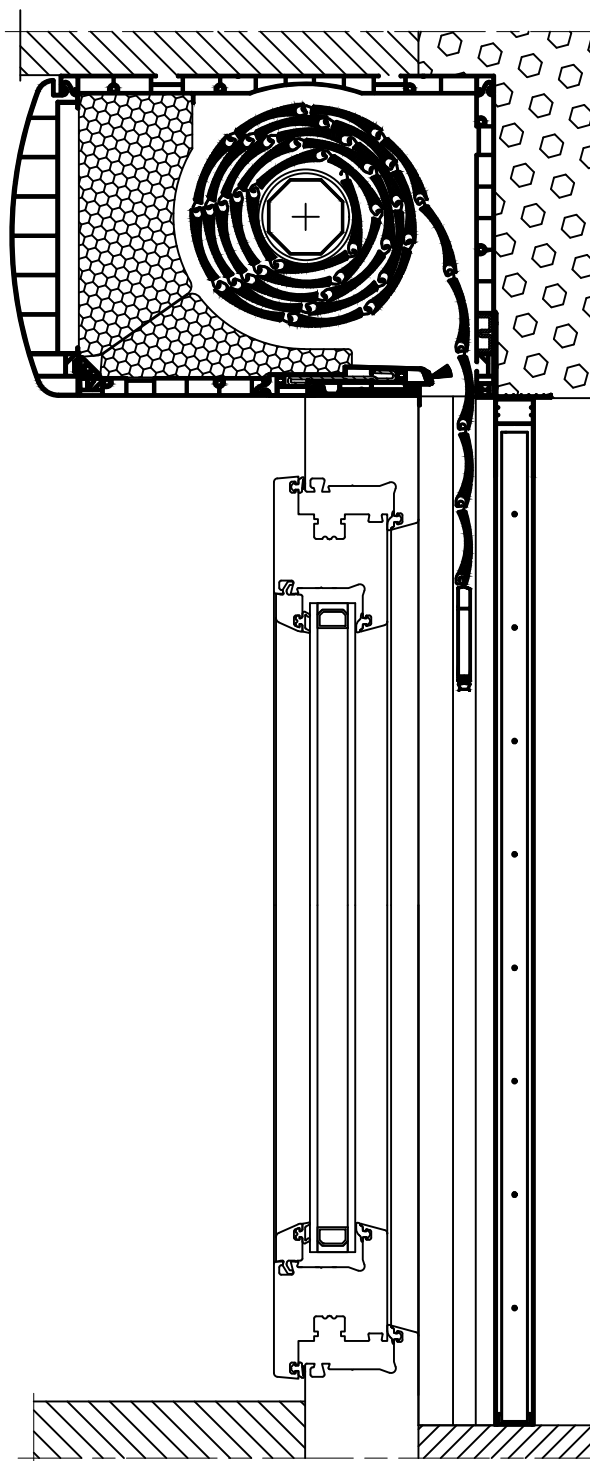

Moskitiery - przykłady zabudowy

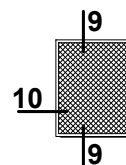

Skala 1:5

10 MPH - 05

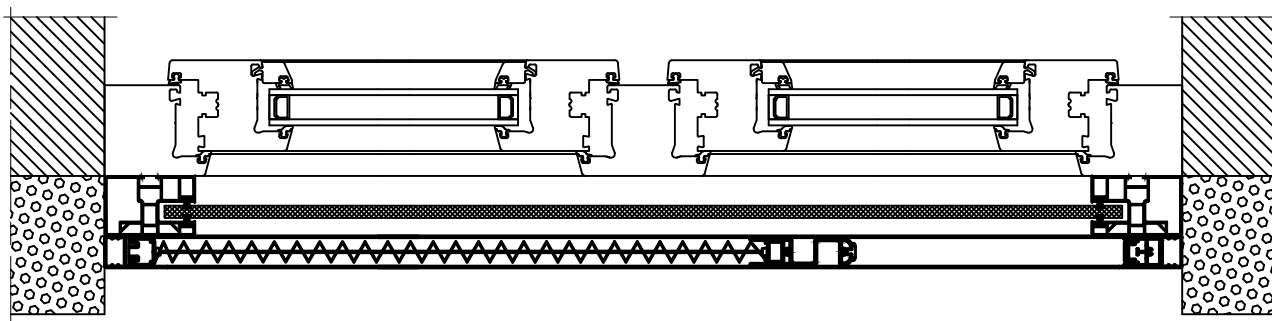

Moskitiery - przykłady zabudowy

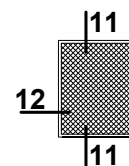

Skala 1:4

11 MPH - 06

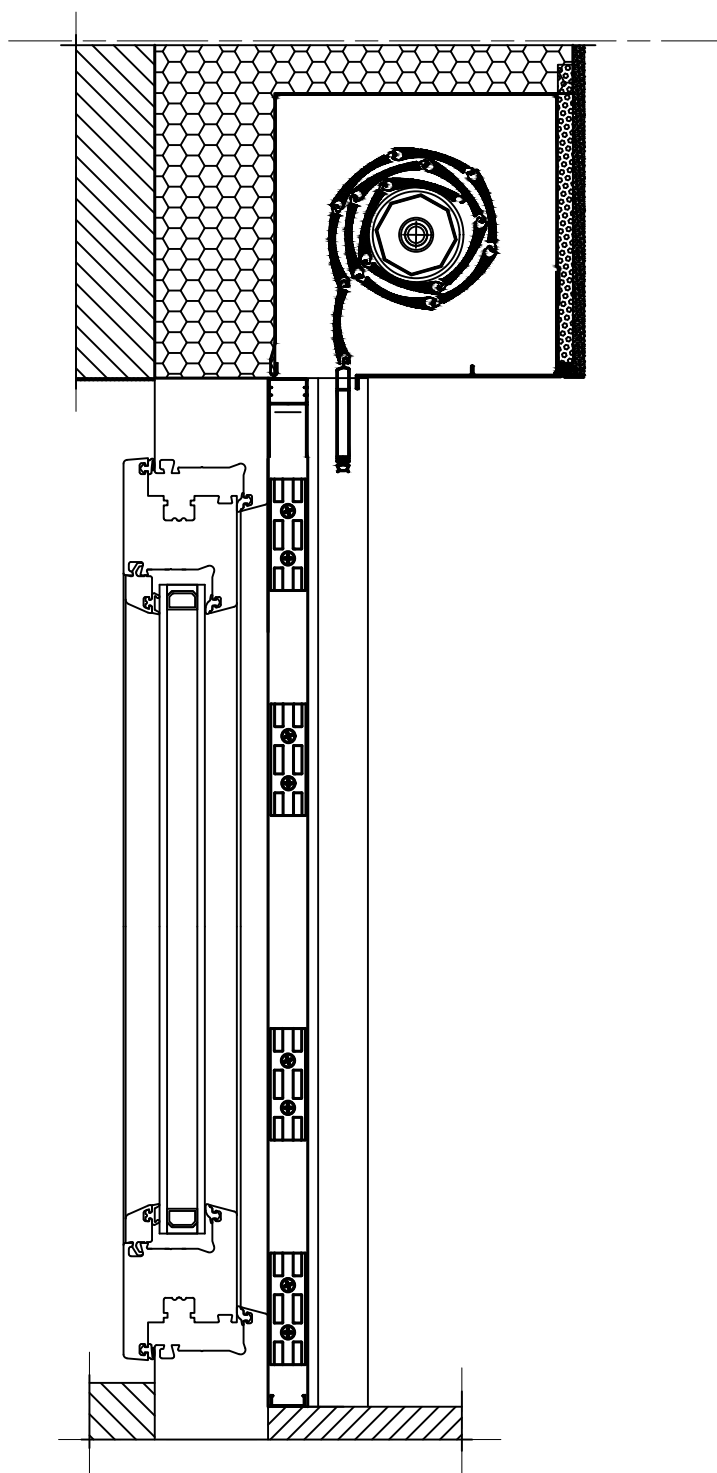

Moskitiery - przykłady zabudowy

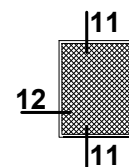

Skala 1:6

12 MPH - 06

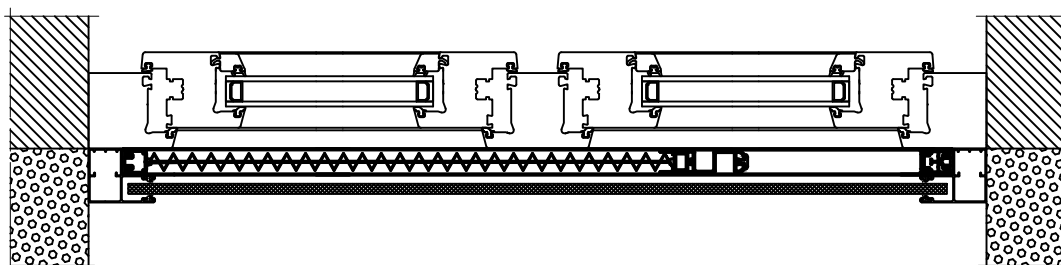

Moskitiery - przykłady zabudowy

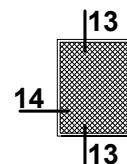

Skala 1:4

13 MPH - 07

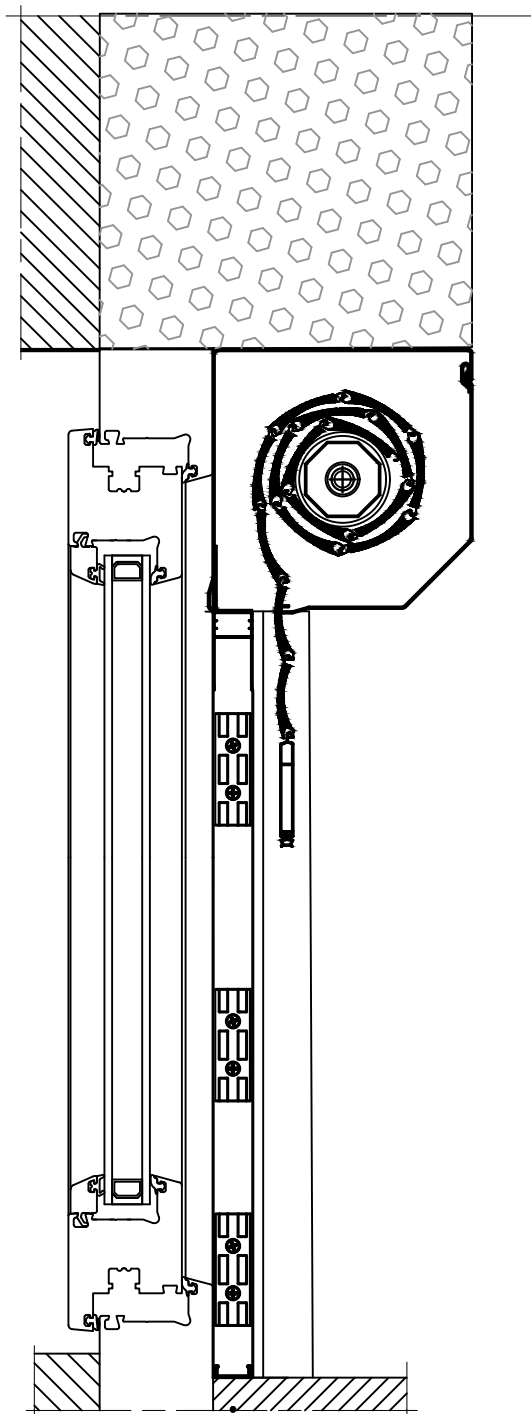

Moskitiery - przykłady zabudowy

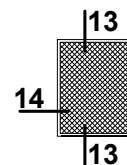

Skala 1:6

14 MPH - 07

